

# Aircraft Flight Manual

For the Airplane

## Lightwing AC4

Document No: LW-RL-Z-002

This document is issued for the following airplane:

Registration: HB-WEC

Serial Number: 004

Date & Signature Lightwing:

25.04.2018, Marco Trüssel, Light Wing AG

## 0.1 Amendments

Any revision of the present manual has to be registered in the following chart.

Rev.	Pages	Description	Date	Approval
-	1..85	1st Edition.	12-May-14	EASA.A.588, 17.6.14
Rev.:0	1..87	Renumbered to document LW-RL-Z-002 - addition heating system - addition gear fairings	02-Mar-16	ELA1-HB LW-RL-Q-003 EASA 10056955 EASA 10056950
Rev.:1	1..88	Minor change "Project 06" - Addition FLARM - Addition LED sight gauge illumination - Addition of approved sections	19-Sep-17	ADxC-48-DC-002
Rev.:2	1..88	AFM Change for EASA project 10062701 Major change "Project 03" - 912iS "Sport"	23-Mar-18	

**0.2 List of approved sections**

Section	Name	Status
2.	Limitations	Approved (EASA.A.588)
3.	Emergency procedures	Approved (EASA.A.588)
5.	Performance	Approved (EASA.A.588)
6.1 & 6.2	Weight and Balance	Approved (EASA.A.588)

## 0.3 List of effective pages

Page	Date	Page	Date	Page	Date
Cover	23-03-18	31	23-03-18	62	23-03-18
1		32		63	
2		33		64	
3		34		65	
4		35		66	
5		36		67	
6		37		68	
7		38		69	
8		39		70	
9		40		71	
10		41		72	
11		42		73	
12		43		74	
13		44		75	
14		45		76	
15		46		77	
16		47		78	
17		48		79	
18		49		80	
19		50		81	
20		51		82	
21		52		83	
22		53		84	
23		54		85	
24		55		86	
25		56			
26		57			
27		58			
28		59			
29		60			
30	61				

## **0.4 Table of contents**

This aircraft flight manual supplement consists of the following parts:

- 1 General
- 2 Limitations
- 3 Emergency procedures
- 4 Normal procedures
- 5 Performance
- 6 Weight and balance / equipment
- 7 Aircraft and systems description
- 8 Handling and maintenance

Following the recommended structure for flight manuals as defined in GAMA Specification No. 1.

The following documents belong to this aircraft flight manual:

- Operation manual for engine ROTAX 912iSc/iS "Sport"
- manuals for installed avionics
  - o Skyview System
  - o Power Flarm
  - o Radio with Intercom
  - o Transponder

The Airplane flight manual must be carried on board the airplane at all times. It should be stored in the aircraft.

## **0.5 Contact information**

Light Wing AG  
Riedenmatt 1  
6370 Stans  
Switzerland  
[www.Lightwing.ch](http://www.Lightwing.ch)

# 1 General

## 1.1 Introduction

This aircraft flight manual includes information and procedures for pilots for safe and effective operation of this aircraft. This aircraft flight manual includes information that should be made available to the pilot according to CS-LSA regulations. It includes further information and procedures which Light Wing AG Company considers useful for the pilot.

The aircraft manual is corrected and amended by EASA

<b>CAUTION:</b>	This airplane flight manual has to be carried on board at all times.
-----------------	--

## 1.2 Certification Basis

The AC4 is certified on 17-Jun-2014 by the European Aviation Safety Agency (EASA) under CS-LSA with type certificate EASA.A.588.

Category:	Light Sport Aircraft;
Noise certificate	ICAO Annex 16, Chapter X.

## 1.3 Warnings, cautions and notes

Statements in this handbook, which are particularly important for safety of flight or operation of the airplane, are highlighted by one of the following notions:

**WARNING:** means that non-observance of the respective procedure leads to immediate or considerable reduction of flight safety.

**CAUTION:** means that non-observance of the respective procedure leads to a reduction of flight safety in the long term.

**NOTE:** shall bring attention to facts which are not directly related to safety of flight, but which are important or unusual.

## 1.4 Descriptive data

The Lightwing AC4 aircraft is a single engine two-seater light sport airplane with side by side seating. It is built in a high strutted wing configuration with a conventional strutted tail.

The aircraft has a dual control system with a single central control stick. The undercarriage is fixed tricycle landing gear type, with the nose wheel steering.

### 1.4.1 Dimensions and important data

#### Dimensions external

wing span (incl. wing tips):	9.446 m
wing span (incl. wing tips lights):	9.565 m
max. length (spinner to rudder tip):	6.950 m
max. height:	2.670 m

#### Wing

wing surface:	12.70 m <sup>2</sup>
---------------	----------------------

#### Aileron

deflection up:	22° (± 2°)
deflection down:	20° (± 2°)

#### Flaps

control system:	electric
deflection:	0°/10°/24° Down ± 2°

#### Horizontal tail

span:	2.910 m
deflection up:	30° ± 2°
deflection down:	30° ± 2°

#### Servo tab (right elevator):

Fletcher tab geared to elevator deflection (angles are with respect to elevator chord)

with elevator 30° UP	26° ± 2° dwn
with elevator neutral	12° ± 2° dwn
with elevator 30° DWN	7° ± 2° up



Pitch trim (left elevator):

Trim tab with an electric actuator at the left hand elevator trailing edge.  
 Geometric deflection versus elevator:  $5^\circ \text{ up} / 27^\circ \text{ dwn} \pm 2^\circ$

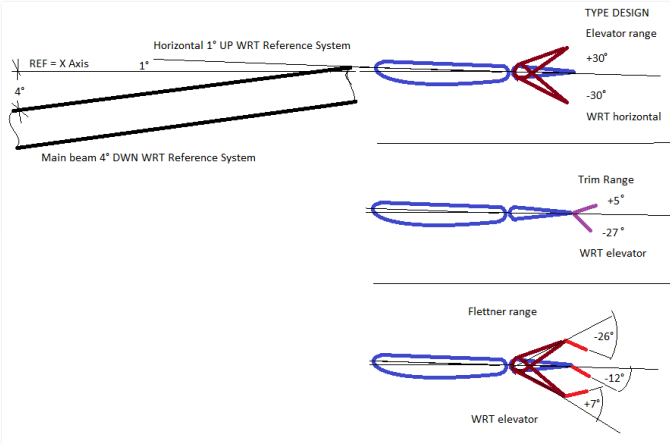

Vertical tail surfaces

surface:  $1.207 \text{ m}^2$   
 deflection: left/right  $25^\circ \pm 2^\circ$

Undercarriage

fixed tricycle landing gear  
 shock absorption/nose gear: elastomer  
 shock absorption/main gear: steel leaf spring  
 wheel base:  $1.851 \text{ m}$   
 wheel track:  $1.916 \text{ m}$   
 main wheels/pressure:  $15 \times 6.00\text{-}6/3.0\text{bar}$   
 nose wheel/pressure:  $4.00\text{-}6/2.7\text{bar}$

Brakes

Central braking at the main gear using floating disk brakes.

## 1.4.2 Powerplant

### Engine:

Rotax 912iSc/iS "Sport" naturally aspirated, 4 Stroke petrol engine, with 4 horizontally opposed cylinders with dry sump lubrication, dual ignition with breakerless capacitor discharge design, fuel injection supplied by a dual electric fuel pump, liquid cooled cylinder heads, ram air cooled cylinders, prop drive gear reduction ratio of 2.43:1.

### Propeller:

Type:	fixed pitch
Blade:	CR3-75 3-blade
Diameter:	1.75 m
Manufacturer:	Neuform Composites GmbH&Co
Blade setting (gaugeable secant):	25° at 365mm from hub centre

## 1.4.3 Three side view

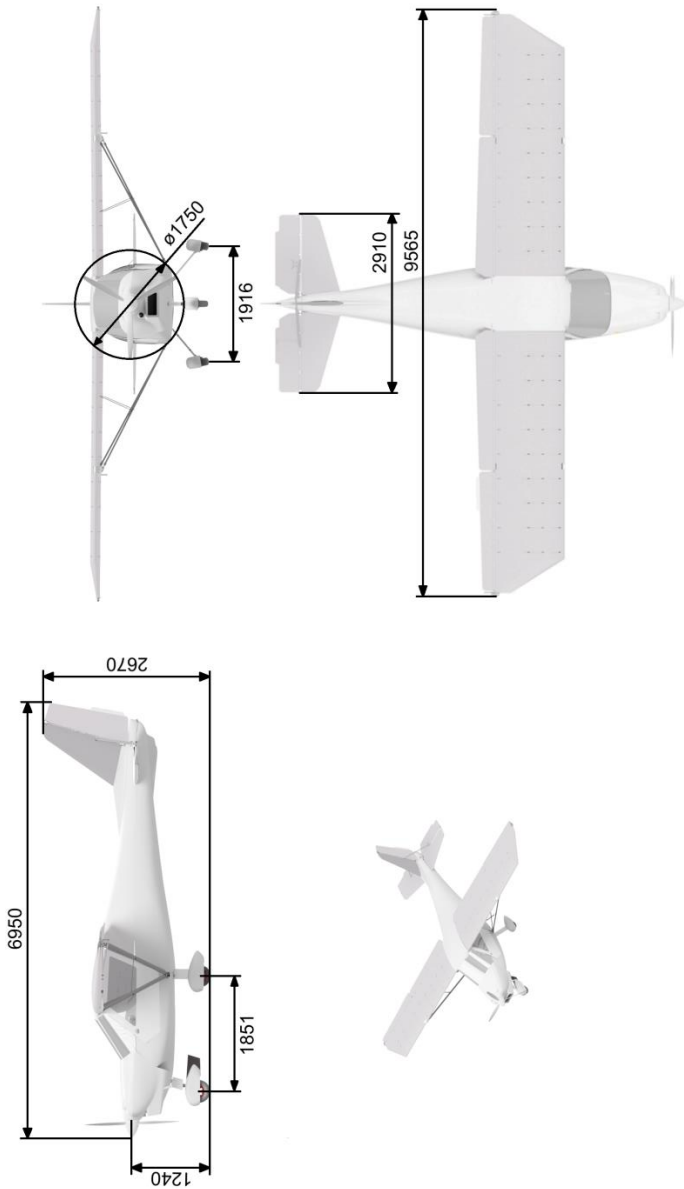

## **2 Limitations**

2.1	General .....	13
2.2	Speeds .....	13
2.3	Airspeed indicator markings .....	13
2.4	Powerplant .....	14
2.5	Powerplant instrument markings .....	15
2.6	Miscellaneous instrument markings .....	16
2.7	Weight limits .....	16
2.8	Approved manoeuvres .....	16
2.9	Manoeuvring load factors .....	16
2.10	Flight crew .....	17
2.11	Kinds of operation .....	17
2.12	Fuel .....	17
2.13	Maximum passenger seating .....	17
2.14	Other limitations .....	18
2.15	Limitation placards .....	18
7.15	Cabin heating system .....	83

## 2.1 General

This section deals with operating limitations, instrumentation and labels required for the safe operation of the aircraft, its engine, systems and equipment.

**CAUTION:** Any violation of the defined limitations must be recorded in the airplane logbook!

## 2.2 Speeds

The speed limits are given in the unit “kilometres per hour” and relate to established values in equivalent and indicated airspeed.

Limits for flight speeds and their importance for the operation are shown in the following chart:

Description	Name	EAS	IAS	Comment
Never exceed speed	$V_{NE}$	196 km/h	210km/h	This speed must never be exceeded
Maneuvering speed	$V_A$	163 km/h	176km/h	Do not make full or abrupt control movements above this speed
Maximum structural cruising speed	$V_{NO}$	163 km/h	176km/h	Speed range above only usable in smooth air
Flaps extended speed	$V_{FE}$	152 km/h	165km/h	Highest permissible speed for flap operation

## 2.3 Airspeed indicator markings

The following table defines markings for the airspeed indicator and explains the meaning of colour codes.

Mark	Range km/h IAS	Description
White arc	76-165	Full flap operating range. (Lower extreme is $V_{S0}$ at maximum weight, flaps set 24°, idle power; Upper extreme is the maximum permissible speed with flaps extended)
Green arc	82-176	Normal operating range (Lower extreme is $V_{S1}$ at maximum weight most forward CG with flaps up, Upper extreme is $V_{NO}$ ).
Yellow arc	176-210	Caution range. Operation in this range only in smooth weather conditions
Red line	210	Maximum speed for all operations ( $V_{NE}$ )

## 2.4 Powerplant

Manufacturer:	Rotax Aircraft Engines
Type:	Rotax 912iSC/iS Sport
Max. take off power:	73.5 kW = 100 HP
Max. take off engine speed (max. 5 minutes):	5800 RPM
Max. continuous power:	72 kW = 97,9 HP
Max. continuous engine speed:	5500 RPM
Max. coolant temperature:	120°C
Max. oil temperature:	130°C
Normal operating oil temperature:	90 to 110°C
Oil quantity	Minimum: 2.5 liter Maximum: 3.0 liter
Oil pressure:	Minimum: 0.8 bar (below 3500 RPM) Normal: 3-5 bar (above 3500 RPM) Maximum: 7 bar (shortly, at cold start)
Fuel pressure:	Minimum: 2.7 bar Maximum: 3.4 bar
Fuel:	MOGAS EN 228 Super / EN 228 Super plus
Alternative:	AVGAS 100 LL = ASTM D910-76 = MIL-G5772
	<u>For usage of AVGAS adhere to instructions in ROTAX 912iSC/iS Sport operating handbook</u>

# Limitations

# Lightwing AC4



Lubricant: high performance motorcycle oil with gear additives with API classification „SG“ or higher, see also Rotax information SI-912-i-001, last edition

Coolant: Conventional e.g. BASF Glysantine Protect Plus G48 anticorrosion, mixture ratio 50% concentrate to 50% water, see Service Instruction SI-92 i-001

Propeller manufacturer: Neuform Composites GmbH&Co  
Propeller type: CR3-75 3-blade  
Diameter: 175cm  
Blade angle (gaugeable secant 365 mm from hub center) 25°  
Rotational speed restriction range: none

## 2.5 Powerplant instrument markings

The instrument markings are programmed in the Stock Flight EMU 912i. It is not permissible to exchange the software in this unit unless mandated by a Service bulletin.

INSTRUMENT	Red	Yellow	Green	Yellow	Red
	Minimum limit	Caution range	Normal range	Caution Range	Maximum limit
RPM indicator	0 - 1500	1500 -1800	1800 -5500	5500 -5800	> 5800
Manifold Air Pressure [hPa]	-	0 - 200	200 -1100	1100 -1150	> 1150
Manifold Temperature [°C]	-	< -25	-25 - 40	40 - 65	> 65
Oil pressure [bar]	0 - 0.8	0.8 - 2.0	2.0 - 5.0	5.0 - 7.0	7.0
Oil temperature [°C]	-	-65 - 50	50 - 110	110 - 130	130
Fuel pressure [bar]	0.0 - 2.7	2.7- 2.8	2.8 - 3.2	3.2 - 3.4	3.4
Fuel Flow [l/hr]	-	-	0-20	20-25	> 30
Coolant Temperature [°C]	-	< 50	50 - 110	110 - 120	> 120
Exhaust Gas Temperature [°C]	-	-	-65 - 900	900 - 950	> 950
Ambient Air Pressure [hPa]	-	< 400	> 400	-	-
Ambient Air Temperature [°C]	-	< -25	-25 – 40	> 40	-
ECU Supply Bus Voltage [V]	< 10	-	10 - 12	-	> 15

## 2.6 Miscellaneous instrument markings

none

## 2.7 Weight limits

Maximum take-off mass:	600 kg
Maximum permissible operational empty mass	405 kg
Maximum loading aft baggage compartment:	25 kg

Datum line for centre of gravity is 1 meter forward of the propeller flange.

The centre of gravity has to be between the following established limiting values aft of datum:

FWD CG limit for TOW<540kg	2885mm aft of datum = 12%MAC
FWD CG limit for TOW=600kg	2940mm aft of datum = 16%MAC
linear limit in between	
AFT CG limit for TOW>450kg	3008mm aft of datum = 21%MAC

## 2.8 Approved manoeuvres

The airplane is certified under the CS-LSA category for which the following manoeuvres are approved:

- All manoeuvres incident to normal flying
- Stalls
- Lazy eight
- Chandelles
- Steep turns, in which the angle of bank is not more than 60°

Aerobatic flight, including spins is not approved.

## 2.9 Manoeuvring load factors

Flap deflection	Permissible load factor	
	positive	negative
0°	+4	-2
10°/24°	+2	0





## ***2.10 Flight crew***

Minimum crew is one pilot.

In general the seat of the pilot in command is on the left side.

The airplane may be operated single seat only using the left seat.

## ***2.11 Kinds of operation***

The airplane is certified for

- Flights following visual flight rules (VFR) during day

Maximum permissible flight altitude

- 12.000 ft

Not approved are:

- Flight at night
- Flight under instrument rules (IFR)
- Flight in known icing conditions
- Spins

### **WARNING:**

Being a light sport airplane category aircraft, approved under CS-LSA, the aircraft does not feature a lightning protection system. Flights in the vicinity of thunderstorm activity must be avoided.

## ***2.12 Fuel***

The aircraft contains a single fuel tank behind the seats.

Fuel capacity:

94 liter

Usable fuel quantity:

90 liter

Unusable fuel quantity:

4 liter

### **NOTE:**

Acceleration during take-off run may cause the low fuel warning light to illuminate with less than 12 liter of usable fuel.

## ***2.13 Maximum passenger seating***

AC4 has one (1) passenger seat.

## ***2.14 Other limitations***

Maximum permissible current 12V plug (charge&supply mode)	5Amp
Maximum permissible current on USB outlet	1Amp

## ***2.15 Limitation placards***

"This airplane must be operated in VFR-day only conditions in accordance with airplane flight manual LW-RL-Z-002"

"Manoeuvre speed  $V_A$  176km/h IAS"

"No intentional spins"

## 3 Emergency procedures

3.1	Introduction .....	20
3.2	Engine emergencies.....	20
3.2.1	Engine malfunction during takeoff run .....	20
3.2.2	Engine malfunction after take off .....	21
3.2.3	Engine malfunction during flight (Restart Procedure).....	21
3.2.4	Lane and Generator warning in flight.....	22
3.2.5	Exceeding engine limits.....	23
3.2.6	Oil pressure below minimum on ground .....	23
3.2.7	Oil pressure below minimum during flight .....	23
3.3	Fires.....	24
3.3.1	Engine fire on ground .....	24
3.3.2	Engine fire during flight.....	24
3.3.3	Electrical fire during flight .....	24
3.4	Glide.....	25
3.5	Landing emergency.....	26
3.5.1	Emergency landing without engine power .....	26
3.5.2	Precautionary landing with engine power .....	26
3.5.3	Landing with flat tire .....	26
3.6	Recovery from unintentional spin .....	27
3.7	Other emergencies.....	28
3.7.1	Malfunctions of electrical system.....	28
3.7.2	Fuel Pressure outside range .....	30
3.7.3	Low fuel warning .....	31
3.7.4	Cockpit smoke/Exhaust gas/CO-contamination.....	31

# Lightwing AC4 Emergency procedures

## 3.1 Introduction

This section presents the checklist including description of recommended procedure for emergency situations.

Emergency situations caused by failures on the aircraft or aircraft's engine are rare when the required maintenance and pre-flight inspections are followed!

Not all emergencies can be foreseen and described in the aircraft flight manual. For this reason, knowledge of the aircraft and its systems as well as pilot's experience in dealing with occurring problems are required.

**CAUTION:** In all emergencies: stay calm and determine the cause.

## 3.2 Engine emergencies

**CAUTION:** In case the engine fuel supply or ignition is interrupted, the propeller will stop if airspeed is too low. Once the propeller has fully stopped, an airspeed approaching  $V_{NE}$  would be required to windmill. Therefore engine restart with a stopped propeller must be performed using the electric starter.

### 3.2.1 Engine malfunction during takeoff run

- Throttle ..... IDLE
- Fuel Shutoff Valve ..... CLOSE
- Engine Key ..... OFF
- Brakes ..... APPLY FULL

# Emergency procedures Lightwing AC4



## 3.2.2 Engine malfunction after take off

Speed ..... 115 km/h IAS  
Fuel Shutoff Valve ..... CLOSE  
Engine Key ..... OFF  
Master Switch ..... OFF  
Landing.....PERFORM

## 3.2.3 Engine malfunction during flight (Restart Procedure)

Speed ..... 115 km/h IAS  
Fuel Shutoff Valve ..... CHECK OPEN  
Engine Key ..... OFF (2sec)  
Engine Key .....rotate to A/B  
Engine Key ..... Rotate to START POWER  
Engine Key ..... Rotate to START UNTIL ENGINE STARTS  
Engine Key ..... RELEASE to A/B

### If engine does not start

Back-Up Power Switch ..... ON  
Repeat attempt as above

### In case the engine cannot be restarted, proceed as follows:

Throttle ..... IDLE  
Engine Key ..... OFF  
Fuel Shutoff Valve ..... CLOSE  
Back-Up Power Switch ..... OFF  
Electrical Consumers..... MINIMUM  
Speed for best glide (Flap UP)..... 110 km/h IAS

### Prior to touch down, after selection of final flap setting:

Avionics Master Switch ..... OFF  
Battery Master Switch ..... OFF  
Safety Harnesses ..... TIGHT

# Lightwing AC4 Emergency procedures

## 3.2.4 Lane and Generator warning in flight

**CAUTION:** A constant warning light indicated a broken sensor. A reset of the engine is not likely to correct the situation and is not considered safe.

### Lane A warning blinking:

A Lane A warning might occur in closed throttle flight.

- Throttle ..... set to min 3000RPM
- Engine Key .....select B
- Lane A warning..... check permanent ON
- Engine Key ..... select A/B
- Lane A warning ..... check OFF

### Lane B warning blinking & generator failure warning

Altitude ..... min 5000ft GND

The procedure results in temporary engine shut down, if minimum altitude cannot be ensured:

Landing..... as soon as practical  
If altitude is sufficient:

- Speed ..... min 140km/h Throttle
- ..... set to min 4000RPM
- Engine Key ..... OFF (2sec)

If propeller does stop proceed with engine restart procedure, otherwise

- Engine Key .....select B
- Lane warnings ..... check A OFF / B ON
- Engine Key .....select A
- Lane warnings ..... check A ON / B OFF
- Engine Key .....select B
- Lane warnings ..... check A OFF / B ON
- Engine Key ..... select AB
- Lane warnings ..... check OFF
- On board voltage ..... check min 13.2 Volt

### Lane A OR Lane B warning constant ON or BOTH warning blinking:

Landing.....AS SOON AS PRACTICAL

## 3.2.5 Exceeding engine limits

### Coolant temperature, oil temperature, exhausts temperature:

Reduce engine power setting to the minimum necessary and carry out precautionary landing. Any exceeding of the maximum admissible coolant or oil temperature has to be entered by the pilot into logbook, stating duration and extent of over-temperature condition.

**CAUTION:** A maintenance inspection should be carried out!

### Engine RPM:

Reduce the engine speed. Any exceeding of the maximum admissible engine speed has to be entered by the pilot into logbook, stating duration and extent of over engine speed.

**CAUTION:** A maintenance inspection should be carried out!

### Oil pressure above permitted range at low ambient temperatures:

Reduce the engine speed and check the oil pressure again once it has reached a higher oil temperature.

**CAUTION:** A maintenance inspection should be carried out!

## 3.2.6 Oil pressure below minimum on ground

Immediately stop the engine and check for reason. Check oil system. Check oil quantity in oil tank

## 3.2.7 Oil pressure below minimum during flight

Reduce engine power setting to the minimum necessary and carry out precautionary landing. Check oil system.

**CAUTION:** A maintenance inspection should be carried out!

# Lightwing AC4 Emergency procedures

## 3.3 Fires

### 3.3.1 Engine fire on ground

Fuel Shutoff Valve ..... CLOSE  
 Engine Key ..... OFF  
 Airplane ..... EVACUATE  
 Fire ..... EXTINGUISH

### 3.3.2 Engine fire during flight

Fuel Shutoff Valve ..... CLOSE  
 Cockpit heating ..... OFF  
 Throttle ..... MAXIMUM  
 Engine Key ..... OFF  
 Airspeed ..... MAXIMUM PERMISSABLE  
 ..... to put out the flames  
 Emergency landing ..... EXECUTE

**WARNING:** Do not try to restart the engine!

### 3.3.3 Electrical fire during flight

Master Switch ..... OFF  
 Fresh air scoops ..... Adjust as required to evacuate smoke  
 Cockpit heating ..... OFF  
 Emergency landing ..... Prepare

**CAUTION:** Electrical fire in the cockpit might also be related to, or damage engine wiring. If fire or generation of smoke continues an emergency landing must be executed.

Fuel Shutoff Valve ..... CLOSE  
 Engine Key ..... OFF  
 Emergency landing ..... EXECUTE



## 3.4 Glide

1. Speed (best glide)..... 110 km/h IAS
2. Landing Field .....SEARCH
3. Safety Harnesses .....TIGHT
4. Landing..... TOUCHDOWN WITH MINIMUM SPEED

The best glide ratio of the AC4 in engine idle condition is 1:6.9

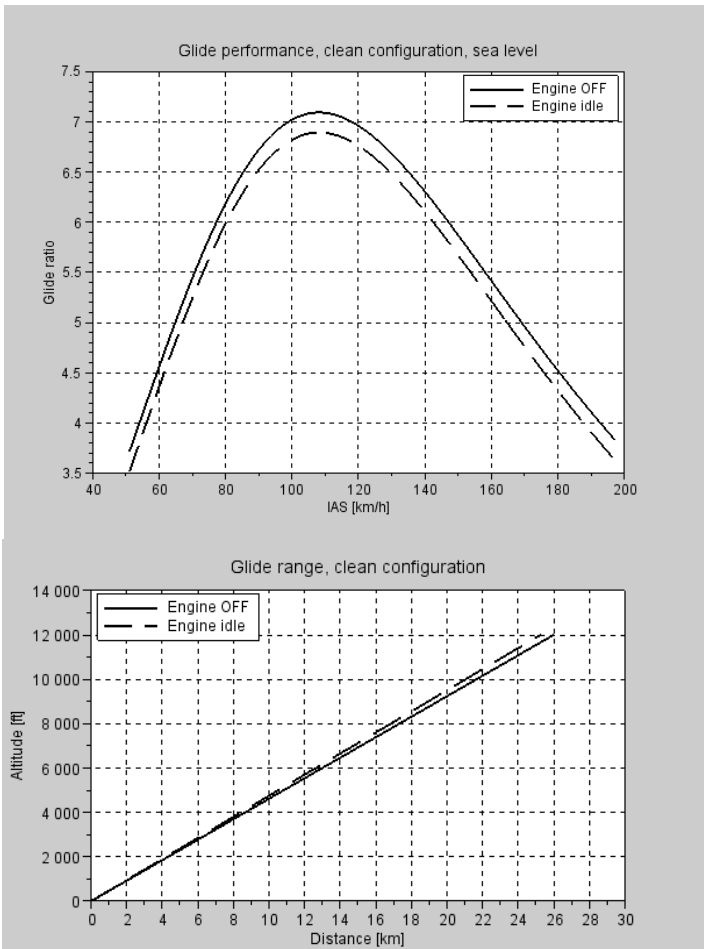

# Lightwing AC4 Emergency procedures

## 3.5 Landing emergency

### 3.5.1 Emergency landing without engine power

**CAUTION:** The missing propeller slipstream reduces elevator authority during flaring.

Safety Harnesses .....TIGHT  
 Fuel Shutoff Valve ..... OFF  
 Engine Key ..... OFF  
 Approach speed .....minimum 115km/h IAS  
 Flaps .....AS REQUIRED  
 Landing.....TOUCHDOWN WITH MINIMUM SPEED

### 3.5.2 Precautionary landing with engine power

A precautionary landing might be required or advisable for the following reasons:

- Suspicion of fire or scorching
- Illumination of low fuel lever warning lights
- Suspicion of fuel leak
- Low oil pressure
- Low fuel level warning

**NOTE:** It is a recommended practice to FLY OVER the selected field, to note terrain and obstructions.

### 3.5.3 Landing with flat tire

In case of a flat tire landing, the approach is the same as for normal landing. In case of flat main tire the touchdown should be made with the good main tire **FIRST**, holding the airplane off flat tire as long as possible with aileron control.

In case of a flat nose tire, the touchdown should be made on main wheels, holding the nose wheel off the ground as long as possible.



## 3.6 *Recovery from unintentional spin*

Should an unintentional spin occur, the following recovery procedure should be used:

Power ..... IDLE  
Aileron ..... NEUTRAL  
Rudder..... First NEUTRAL  
.....if needed approximately 1/2 against rotation  
Elevator ..... UNLOAD

Hold this control inputs until the rotation stops. After the rotation stops:

Rudder..... NEUTRAL  
Elevator ..... RECOVER FROM DIVE

# Lightwing AC4 Emergency procedures

## 3.7 Other emergencies

### 3.7.1 Malfunctions of electrical system

Over/under voltage indication, generator warning:

Engine Key ..... SELECT B  
 ..... wait for two seconds  
 Engine Key ..... SELECT A  
 ..... wait for two seconds  
 Engine Key ..... SELECT B  
 ..... wait for two seconds  
 Engine Key ..... SELECT A/B

If malfunctioning has been restored, the generator will resume charging and the light will go off as a proof that over/under voltage condition was temporary.

If the malfunctioning persists:

Nonessential electrical equipment ..... OFF  
 Backup Switch ..... ON  
 Voltage Indication ..... Check  
 Flight ..... Terminate as soon as practical

Failure of EMS power supply:

**NOTE:** If the engine electric power supply (Gen A) fails then the engine automatically switches one-time over to the second power supply (Gen B).

**WARNING:** No charging of battery

**NOTE:** Failure of both engine power supplies (Gen A&B) results in engine stoppage due to missing electric power for the fuel pump.

# Emergency procedures Lightwing AC4



If engine stops:

- Back-Up switch ..... ON
- Engine start ..... According to 3.2.3
- Electrical consumers ..... Reduce to minimum
- Flight ..... TERMINATE AS SOON AS POSSIBLE

# Lightwing AC4 Emergency procedures

## 3.7.2 Fuel Pressure outside range

**NOTE:** Transient conditions (throttle slams) can result in temporary engine coughing and fuel pressure limit exceeding. Those temporary conditions are normal but should not last longer than 2 seconds.

If the fuel pressure is too high:

**NOTE:** Reduce engine power setting to the minimum necessary and carry out precautionary landing

Fuel pump ..... CHECK MAIN PUMP ON; AUX PUMP OFF  
 If this has no effect:  
 Fuel Pump .....AUX PUMMP ON; MAIN PUMP OFF  
 Continue operation on the pump which shows lesser fuel pressure  
 If pressure continues to be out of limit:  
 Power .....REDUCE TO MINIMUM REQUIRED  
 Flight .....LAND AS SOON AS POSSIBLE  
 If pressure is restored within limit:  
 Flight ..... LAND AS SOON AS PRACTCAL

If the fuel pressure is too low:

**NOTE:** Limited flight operation with reduced power is possible. Carry out precautionary landing

Fuel pump .....AUX PUMP ON  
 If this has no positive effect:  
 Fuel pumps..... BOTH ON  
 If this has no positive effect:  
 Flight .....LAND AS SOON AS POSSIBLE  
 If pressure is restored within limits  
 Flight ..... LAND AS SOON AS PRACTCAL

### 3.7.3 Low fuel warning

If the low fuel warning flickers the remaining usable fuel is less than 2liter. If the low fuel warning illuminates permanent the remaining usable fuel in the fuel tank is less than 1liter!

A precautionary landing must be initiated immediately.

<b>WARNING:</b>	Remaining powered flight time with low fuel warning illuminated is limited to as little as 3 minutes depending on the airplane attitude.
-----------------	--

<b>NOTE:</b>	Acceleration during take-off run may cause the low fuel warning light to illuminate with less than 12 liter of usable fuel.
--------------	---

### 3.7.4 Cockpit smoke/Exhaust gas/CO-contamination

If the pilot suspects a defect of either the exhaust or the heating system either by smell, smoke, CO-warning sticker active or any other means:

- Cabin heat ..... OFF
- Door window ventilation ..... OPEN and directed to occupant face
- Power ..... reduce to minimum required

If this has no positive effect:

Flight ..... LAND AS SOON AS POSSIBLE

If conditions are restored

Flight ..... LAND AS SOON AS PRACTICAL

## **4 Normal procedures**

4.1	Introduction .....	33
4.2	Daily inspection .....	33
4.3	Pre-flight inspection.....	34
4.4	Normal procedures.....	36
4.4.1	Prior to engine start.....	36
4.4.2	Engine start up.....	36
4.4.3	Taxi .....	37
4.4.4	Before take off.....	37
4.4.5	Take off.....	38
4.4.6	Climb.....	39
4.4.7	Cruise.....	39
4.4.8	Descent.....	39
4.4.9	Before landing.....	39
4.4.10	Landing.....	39
4.4.11	After landing.....	40
4.4.12	Shut down & Parking.....	40





## 4.1 Introduction

This chapter gives check-lists and description of operating procedures under normal conditions.

## 4.2 Daily inspection

**CAUTION:** Even if the AC4 has been operated the day before, it is still mandatory to perform a thorough inspection and pre-flight check prior to the first flight of the day.

### Cockpit check

All switches..... OFF

**WARNING:** Unintentional engine start may have dangerous consequences. Therefore make sure ignition and master switches are OFF.

- Throttle .....free to move
- Flight controls ..... free to move and correct
- Flaps .....check operation (master switch on)
- Flap-Bolts ..... check safety measures
- Circuit breakers ..... pressed in
- Cleanliness .....no unsecured objects
- Restraint system..... check condition
- Brake ..... check adjustment of brake lever
  - ..... check adequate brake pressure
  - ..... check function of park brake
- Cabin heat control .....free to move

### Engine

- Quantity of coolant fluid .....check, top up as needed
- Oil..... check, top up as needed (refer ROTAX Handbook)
- Hoses .....check oil, coolant and fuel hoses for leaks

**NOTE:** For detailed description of the procedure to check the engine and the minimum and maximum quantities of oil and coolant liquid refer to the Rotax 912iSC/iS Sport Operation Manual

**WARNING:** The engine must not be started with any visible leak of operating fluids!

## 4.3 Pre-flight inspection

### Engine section

- General condition ..... check for signs of leaking fluid
- Engine and Cowling ..... secure and undamaged
- All inlets ..... unobstructed
- Propeller ..... check clean and undamaged  
..... check bolts secure
- Access hatch ..... open
- Coolant Level ..... check correct
- Oil Level ..... open oil hatch and oil tank cap  
..... rotate propeller slowly until gurgling noise is audible  
..... check oil level in limits, refill if needed  
..... close oil tank cap
- Access hatch ..... close
- Nose Gear ..... check tyre pressure  
..... check tyre condition  
..... check tyre creep

### Left cockpit

- Left door ..... check locking
- Seat and Harness ..... check secure
- Foreign objects ..... check
- Flap Control Linkage ..... check secure
- Cockpit Area inside and out ..... check no loose equipment
- Cockpit controls ..... unrestricted and correct movement
- Instruments ..... check serviceable

### Left wing

- Left Flap Control Hinges ..... check secured



- Left Wing .....check structure and covering and zippers (3)
- Wing tip light .....secured
- Left Wing Strut ..... check attachment secured
- Left Aileron Control Linkage and Hinges ..... check secured
- ASI Pitot Tube .....check unobstructed

## Left fuselage

- Left Side of the Fuselage ..... check undamaged
- Antennas on tail covers ..... check secured
- Left Main Gear ..... check tyre pressure
- ..... check tyre condition
- ..... check tyre creep

## Tail

- Tail Section .....check secure and surfaces undamaged
- Elevator Hinges and Control Linkage ..... check secured
- Trim Tab and Linkage ..... check secured
- Flettner tab and linkage ..... check secured
- Rudder Hinges and Control Cables ..... check secured
- Struts ..... check secured

## Right fuselage

- Right Side of the Fuselage ..... check undamaged
- Fuel ..... drain and check for contamination
- Fuel vent .....check unobstructed
- Fuel Filler Cap ..... check secured
- Right Main Gear ..... check tyre pressure
- ..... check tyre condition
- ..... check tyre creep

## Right wing

- Right Aileron Control Linkage and Hinges ..... check secured
- Right Wing Strut ..... check attachment secured
- Right Wing .....check structure and covering and zippers (3)
- Wing tip light .....secured
- Right Flap Control Hinges ..... check secured

## Right Cockpit

- Right door ..... check locking
- Seat and Harness ..... check secure
- Inside ..... Check fuel qty in sight gauge
- Foreign objects ..... check
- Windscreen ..... check clear and undamaged

## 4.4 Normal procedures

### 4.4.1 Prior to engine start

Preflight Inspection ..... COMPLETE  
 Circuit Breakers ..... ALL IN  
 Avionics Master Switch ..... OFF  
 All Electrical Consumers ..... OFF  
 Fuel Pump ..... MAIN  
 Control ..... free to move  
 Instruments ..... SET

### 4.4.2 Engine start up

Parking Brake ..... SET  
 Fuel Valve ..... OPEN  
 Master Switch ..... ON  
 Fuel QTY ..... CHECK  
 ACL ..... ON  
 EMU Display ..... CHECK  
 Engine Key ..... A/B  
 Engine Key ..... Rotate to Start Power and HOLD  
 Lane A Warning Light ..... CHECK OFF  
 Lane B Warning Light ..... CHECK OFF  
 Fuel Pressure ..... CHECK (min 3.0 bar)  
 Throttle ..... : 50% (±5%)  
 Propeller Area ..... CLEAR  
 Engine Key ..... Rotate to START until engine starts (max 10sec)  
 Engine Key ..... RELEASE to A/B

**WARNING:** Shut down engine immediately if oil pressure fails to rise within 10sec

Oil Pressure ..... CHECK  
 Throttle ..... SET 2000 RPM  
 Engine Instruments ..... CHECK  
 Oil Temperature ..... wait 2 minutes



Generator warning..... Check OFF

If generator warning active:

Throttle ..... Set 2800 RPM

Generator warning..... wait, check OFF

Avionics Master Switch..... ON

MFD .....set QNH

### 4.4.3 Taxi

Parking Brake ..... RELEASE

Brakes ..... CHECK

Nose Wheel Steering..... CHECK

Flight Instruments ..... CHECK

### 4.4.4 Before take off

Parking Brake ..... SET

Safety Harnesses ..... ADJUSTED and FASTEND

Doors..... CLOSED and LATCHED

Oil Temperature..... CHECK (min 50° C)

Throttle ..... SET 4000 RPM

..... Check CHK->GEN Warning on EMS Display disappeared

Engine Key ..... SELECT B

..... Observe RPM drop not greater than 180

..... Monitor Instruments and EMU Display

..... Check Lane A Lamp illuminated

Engine Key ..... SELECT A

..... Observe RPM drop not greater than 180

..... Monitor Instruments and EMU Display

..... Check Lane B Lamp illuminated

Engine Key ..... B

..... Check Lane A Lamp illuminated

Engine Key ..... A/B

..... Check Lane A and Lane B Lamps extinguished

**NOTE:** Change from A/B to B to A and back must not be executed fast. Wait at each selected position that the according Lane warning as are ON/OFF as applicable to the selected position.  
 Never switch over directly from A/B to A or from A to A/B without holding at B

- Fuel Pressure ..... CHECK
- Fuel Pump ..... AUX
- Fuel Pressure ..... CHECK
- Fuel Pump ..... BOTH
- Fuel Pressure ..... CHECK
- Throttle ..... IDLE  
 ..... Idle RPM should be around 1400
- EMS Power Supply ..... CHECK  
 ..... Minimum Voltage of 12V at each Lane
- Flaps ..... SET for TAKEOFF
- Elevator Trim ..... SET for TAKEOFF
- Flight Instruments ..... SET
- Avionics ..... SET
- ELT ..... ARMED
- Take-off Briefing ..... PERFORM
- Transponder ..... AS REQUIRED
- Runway Heading ..... CHECK and COMPARE
- External lights ..... ON as applicable

### 4.4.5 Take off

- Fuel Pump ..... BOTH
- Throttle ..... FULL POWER
- Engine RPM ..... CHECK (min 5000 RPM)
- Airspeed ..... CHECK
- Rotate ..... 95 km/h IAS



## 4.4.6 Climb

Flaps ..... AS REQUIRED  
Speed ..... 114km/h IAS  
Fuel Pump ..... MAIN  
Engine RPM ..... REDUCE for fuel flow below 20l/h

## 4.4.7 Cruise

Flaps ..... UP  
Throttle ..... AS REQUIRED  
Engine Instruments ..... CHECK

**NOTE:** Once a day the oil temperature should exceed 100°C for at least 15min in order to boil out any condensation water. To reach this oil temperature cruise engine RPM settings above 5000 are required.

## 4.4.8 Descent

Approach Briefing ..... PERFORM  
Altimeter ..... SET to QNH

## 4.4.9 Before landing

Safety Harnesses ..... TIGHT  
Parking Brake ..... CHECK RELEASED  
Airspeed ..... BELOW 150 km/h IAS  
Flaps ..... AS REQUIRED  
Throttle ..... 3000RPM  
Fuel Pumps ..... BOTH

## 4.4.10 Landing

Approach Speed ..... 120 km/h IAS  
Flaps ..... AS REQUIRED  
Throttle ..... min 2500RPM  
Airspeed in Final ..... 110 km/h IAS

**NOTE:** Landing is possible with all flap positions.

## 4.4.11 After landing

Throttle ..... IDLE  
 Flaps .....RETRACT  
 Transponder ..... STBY  
 Fuel Pump ..... MAIN

## 4.4.12 Shut down & Parking

Parking brake ..... SET  
 Avionics Master Switch ..... OFF  
 Engine Instruments ..... CHECK  
 Throttle ..... IDLE  
 Elevator Trim .....SET FOR TAKE OFF  
 Electrical Equipment ..... OFF  
 Engine Key ..... OFF  
 Master switch ..... OFF  
 Parking brake ..... AS REQUIRED

**NOTE:** There should be at least a 5 minute elapse between landing and switching off the engine



# 5 Performance

- 5.1 Introduction .....42
  - 5.1.1 Use of performance tables .....42
  - 5.1.2 ISA Conversion .....44
  - 5.1.3 Pressure to density altitude conversion .....45
- 5.2 Approved performance data .....46
  - 5.2.1 Airspeed indication error .....46
  - 5.2.2 Stall speeds.....47
  - 5.2.3 Take off distances .....47
  - 5.2.4 Landing distance .....48
  - 5.2.5 Climb performance .....49
- 5.3 Additional performance data.....52
  - 5.3.1 Cruise performance.....52
  - 5.3.2 Range and endurance.....53
  - 5.3.3 Balked landing climb performance.....55
  - 5.3.4 Take off performance on grass.....55
  - 5.3.5 Demonstrated cross wind component.....56
  - 5.3.6 Noise.....56

## 5.1 Introduction

This chapter contains all relevant data for correct and detailed flight planning from take-off to landing. Graph and tabulated data are based on:

- good condition of airplane and engine
- average pilot experience

All performance data are based on flight test and corrected for standard atmospheric conditions (ISA = 15° C and 1013,2 [hPa] at sea level).

The influence of the following parameters on performance is determined analytically:

- airspeed
- outside air temperature
- weight

Speeds, unless stated otherwise, are indicated airspeeds (IAS).

### 5.1.1 Use of performance tables

Performance data is presented in tables to account for various parameters, such as altitude, temperature and weight. Additional information is given with each table.

Performance data do not include factors of safety and do not account for varying pilot skills or service condition of the airplane. The stated performance is achieved when using the respective procedures.

Influence of parameters not included in the presented data has to be accounted for by the pilot. These are for instance the influence of bad grass runway (wet, uneven, high grown grass), crosswind influence on take-off and landing performance, and wind influence on range and endurance.

Unless stated otherwise, altitudes given are as density altitudes. For standard conditions density altitude = pressure altitude. In all cases, density altitude has to be determined according 5.1.2 und 5.1.3 for correct determination of performance.

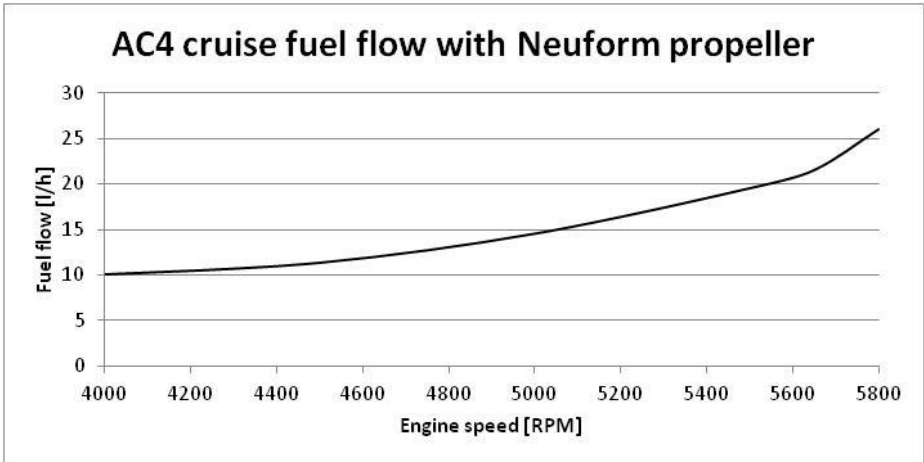
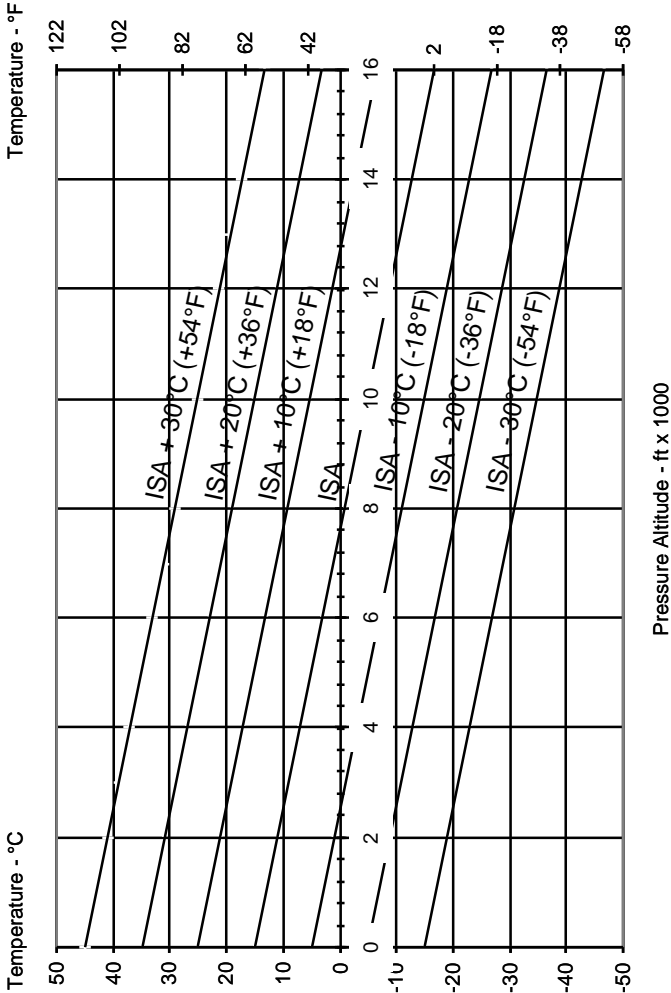

Figure 5.1 Fuel consumption graph

## 5.1.2 ISA Conversion

The influence of actual outside temperature on density altitude can be determined with the following diagram.



## 5.1.3 Pressure to density altitude conversion

Procedure:

- A.) determine pressure altitude by ISA-conversion
- B.) determine intersection of outside air temperature with isobar line
- C.) read density altitude on right side of diagram

Example: pressure altitude = 8500ft, outside air temp. = -6C; result: density altitude = 8000ft

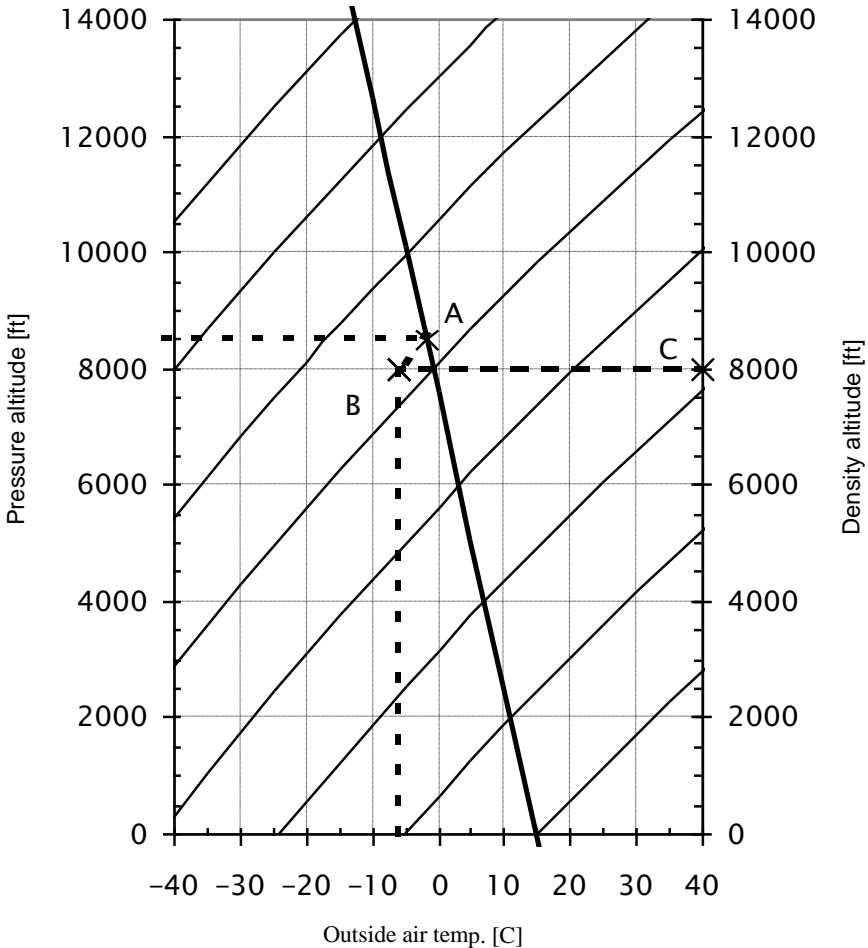

## 5.2 Approved performance data

### 5.2.1 Airspeed indication error

Unless specifically stated all speed data in this handbook relate to indicated airspeed. The airspeed indication error has been determined to be small towards the stall but up to 8% at higher speeds. The error is largely dependent on the airspeed and less on the effects of flap and power setting.

km/h IAS	82	100	130	150	170	190	210
km/h CAS	81	96	121	139	157	176	196

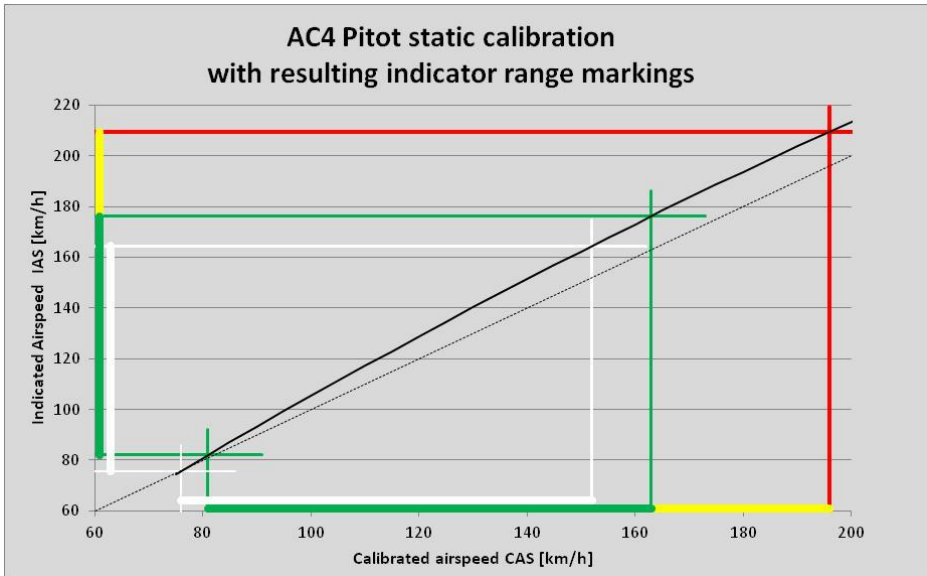

Figure 5.2 Airspeed indication error

## 5.2.2 Stall speeds

$V_S$ km/h IAS	Bank angle				
Flap	0°	15°	30°	45°	60°
0°	82	84	90	101	123
10°	78	80	86	97	118
24°	76	77	83	94	114

## 5.2.3 Take off distances

The presented data relate to normal take off procedure according to 4.4.5 in zero wind and the following conditions:

Flaps: 10°

Power: Full throttle

Runway: Tarmac/Concrete no runway slope

G = 600 kg	Field elevation	outside air temperature [°C]			
	[ft]	ISA-15	ISA	ISA+10	ISA+20
Ground roll [m]	0	118	138	153	168
	2000	132	155	171	189
	4000	148	174	193	213
	6000	167	195	217	241
distance to clear a 50 ft (15 m) obstacle [m]	0	236	276	304	335
	2000	264	309	343	377
	4000	295	348	386	426
	6000	332	392	435	482

G = 500 kg	Field elevation	outside air temperature [°C]			
	[ft]	ISA-15	ISA	ISA+10	ISA+20
Ground roll [m]	0	71	83	91	101
	2000	79	93	103	114
	4000	89	105	117	129
	6000	100	118	130	145
distance to clear a 50 ft (15 m) obstacle [m]	0	141	166	182	201
	2000	159	187	205	226
	4000	178	208	231	256
	6000	199	235	261	289

- Ground roll distance
- increase approx. 20% per 5 kts tailwind
  - decrease approx. 15% per 10 kts headwind
  - decrease/increase approx. 10% per 1° runway slope
  - increase approx. 20% for takeoff on dry short mown grass
  - increase approx. 30% for takeoff on wet short mown grass

## 5.2.4 Landing distance

The presented data relate to normal landing procedure according to 4.4.10 in zero wind and the following conditions:

Flap: 24°

Power: 2500RPM in approach/ Idle after touch down

Runway: Tarmac/Concrete no runway slope

G = 600 kg	Field elevation	outside air temperature [° C]			
	[ft]	ISA - 15	ISA	ISA + 10	ISA + 20
Ground roll distance [m]	0	231	244	253	261
	2000	249	263	272	281
	4000	268	282	292	302
	6000	288	305	315	-
Distance to clear a 50 ft (15m) obstacle [m]	0	507	535	553	572
	2000	546	575	595	615
	4000	587	619	641	662
	6000	633	667	691	-

- Ground roll distance
- increase approx. 20% per 5 kts tailwind
  - decrease approx 15% per 10 kts headwind
  - decrease/increase approx. 10% per 1° runway slope
  - increase approx. 30% for takeoff on dry short mown grass
  - increase approx. 60% for takeoff on wet short mown grass



## 5.2.5 Climb performance

The presented data relate to normal procedure climb according 4.4.6 in zero wind and the following conditions:

- Flap: 0°
- Power: Full throttle
- Airspeed  $V_Y$ : 108 km/h IAS for best rate of climb
- Airspeed  $V_X$ : 85 km/h IAS for best angle of climb at SL

### Rate of climb

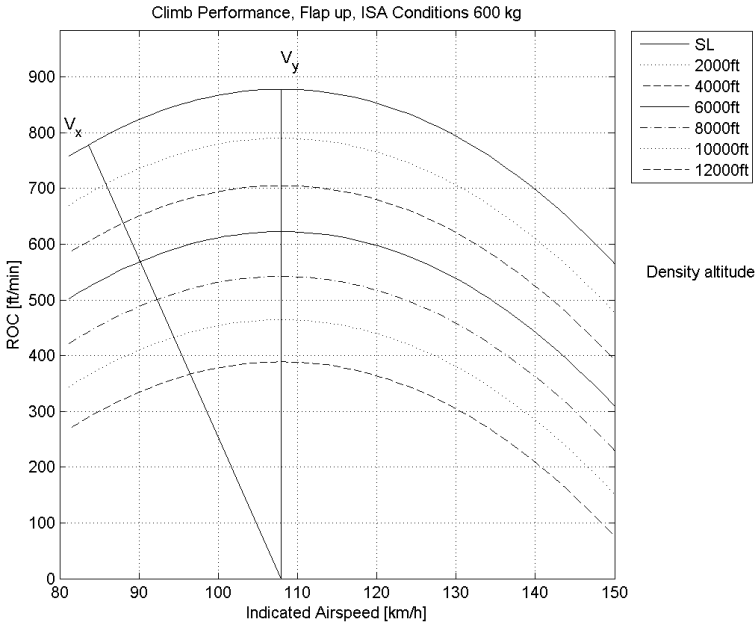

For lesser weights the climb performance increases are almost linear.

$$\text{Rate of climb}_{TOW} = \text{Rate of climb}_{MTOW} * MTOW/TOW$$

Example:

Best rate of climb at 500kg TOW at sea level.

$$\text{Rate of climb}_{500kg} = 730\text{ft/min} * 600\text{kg}/500\text{kg} = 876\text{ft/min}$$

## Time to altitude:

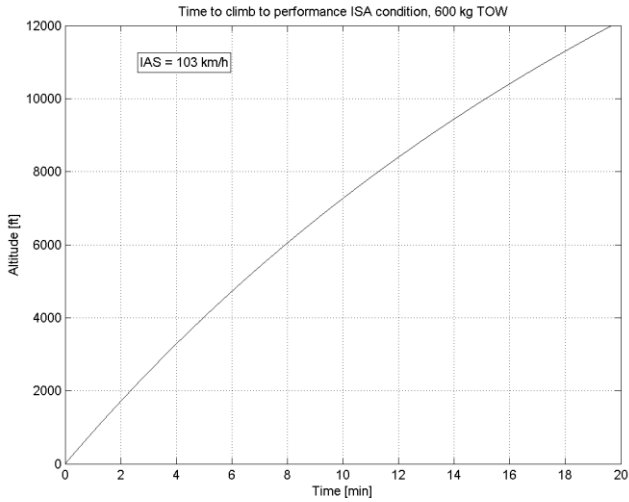

## Distance to altitude:

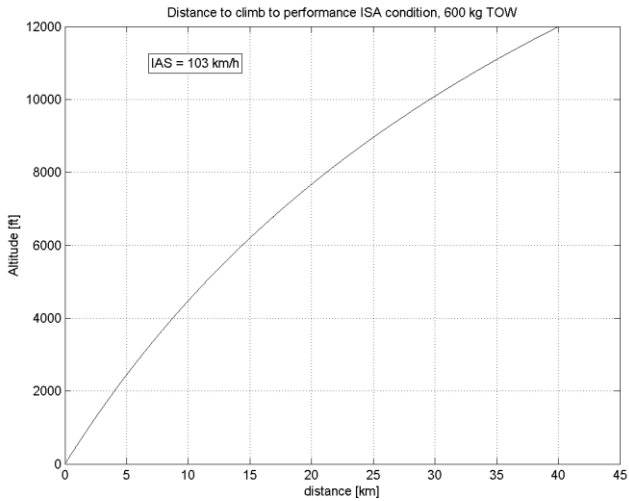



## Fuel to altitude:

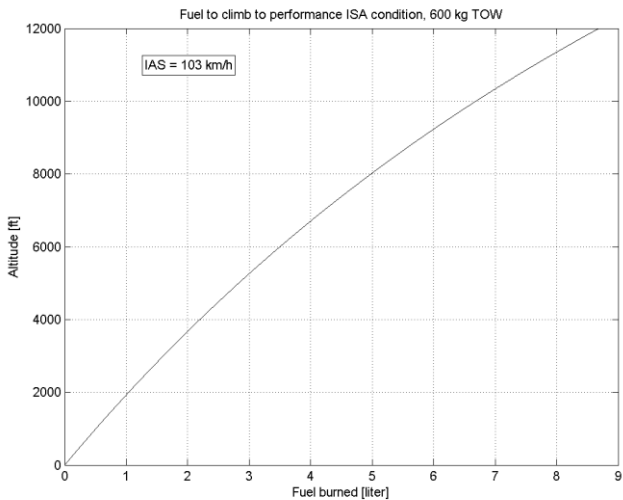

## 5.3 Additional performance data

### 5.3.1 Cruise performance

The presented cruise performance is valid ISA conditions and MTOW 600kg

#### Cruise performance IAS

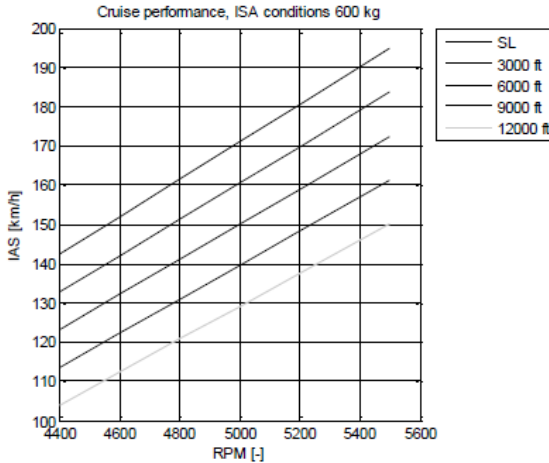

#### Cruise performance TAS

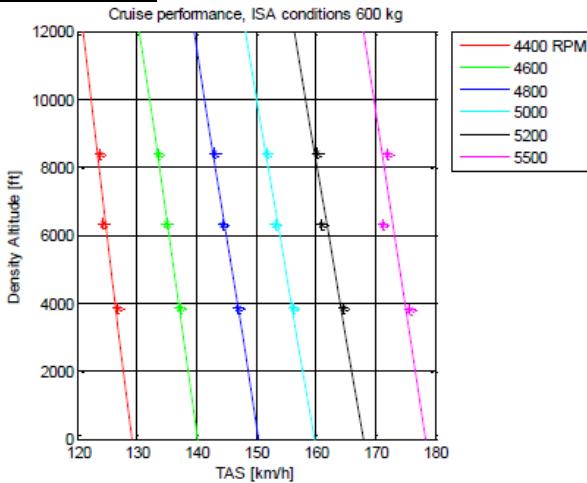



## 5.3.2 Range and endurance

All data in this chapter relate to standard conditions and zero wind.

The stated range and endurance data are valid for:

- Take off with maximum take off mass 600kg
- Full fuel tank 90liters usable

The data includes fuel consumption for

- Fuel for engine start, warm up and taxi 3liters,
- Climb at 114 km/h IAS
- Time for descent assumed at 500ft/min descent rate
- Fuel for descent assumed at 4l/h
- Distance for descent calculated with 140km/h IAS
- Fuel reserve 8liter (=30min at 5200RPM)

### Range

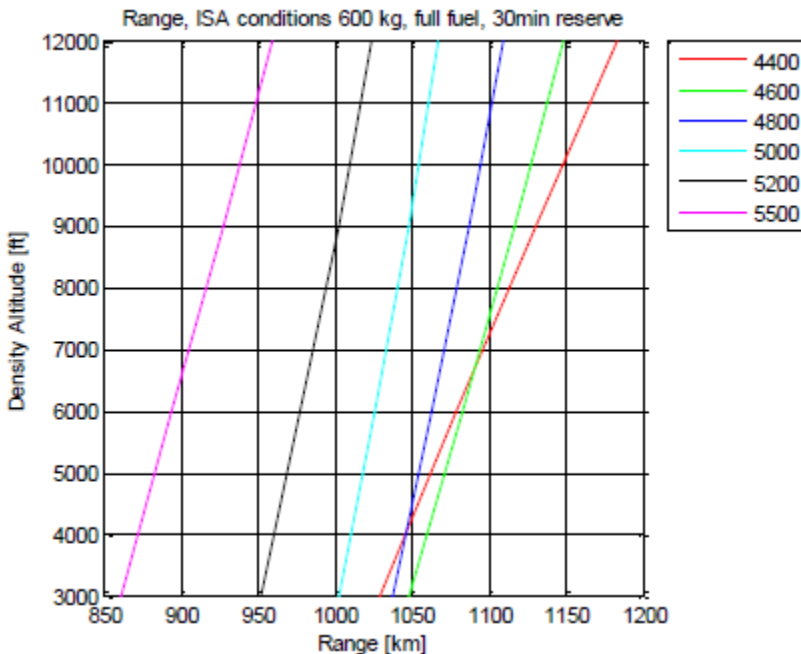

## Endurance

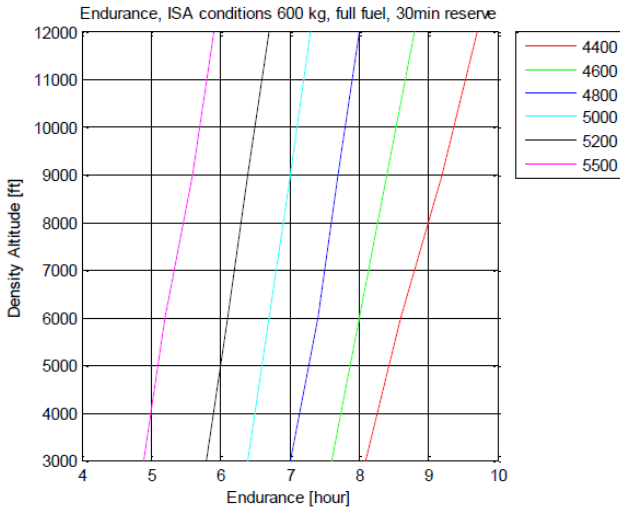

## 5.3.3 Balked landing climb performance

The presented data relate to zero wind and the following conditions:

Flap: 24°

Power: Full throttle

Airspeed  $V_Y$ : 112 km/h IAS for best rate of climb

Airspeed  $V_X$ : 105 km/h IAS for best angle of climb at SL

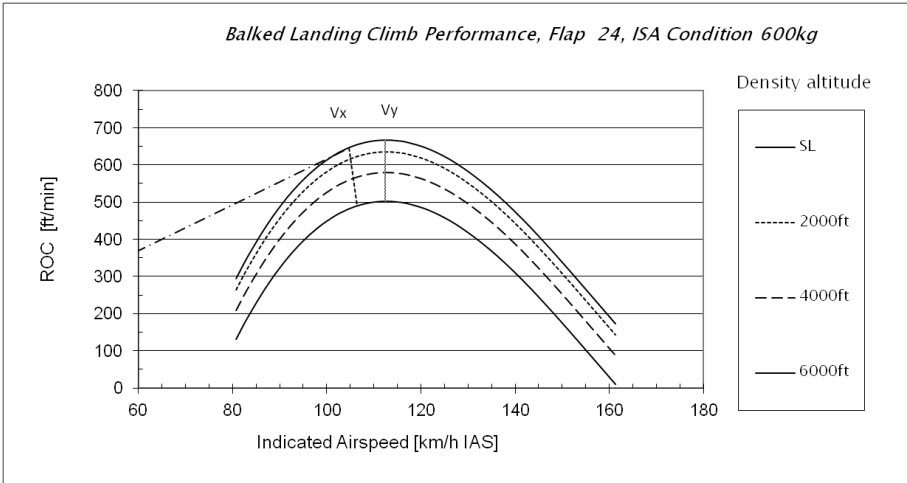

During a balked landing manoeuvre, especially in high density altitude conditions, after acceleration to 112 km/h ISA flaps should be retracted to 10° then to 0°.

Climb performance with Flap 10° is only marginally better.

## 5.3.4 Take off performance on grass

Take off performance on grass depends on numerous factors such as grass height and surface condition. The take-off roll distance shown in chapter 5.2.3 should be assumed to increase by at least 20% for dry, short mown grass and 30% for wet, short mown grass.

## 5.3.5 Demonstrated cross wind component

The demonstrated cross wind component for the AC4, which may or may not be limiting, is 10KTS.

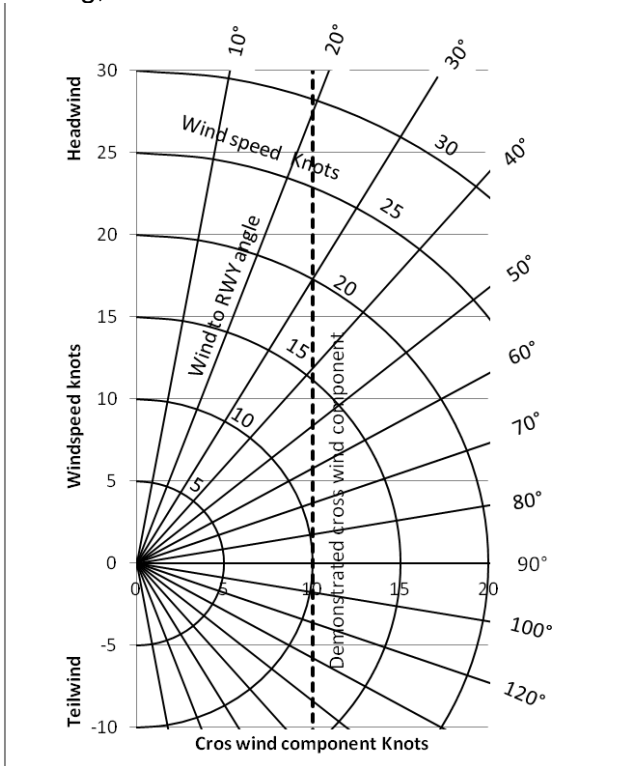

## 5.3.6 Noise

The noise level of the AC4, according to ICAO Annex 16, Chapter X, amounts to 66.2dB(A).



## 6 Weight and balance / equipment

### 6.1 Introduction

This chapter defines the range of loading within which the airplane may be operated safely.

Procedures for weighing, calculation methods to determine limits of loading and lists of equipment available for this airplane are found in the maintenance manual LW-RL-Z-004.

The weighing record sheet (chapter 6.2.1) reflects actual status of empty mass and empty mass centre of gravity at time of last weighing.

The AC4 reference system for weight and balance is:

Datum: 1000 mm forward of propeller flange plane  
Levelling: fuselage main beam 4° nose down

For weighing the airplane the relevant weighing stations and data are:

Nose gear: 1460 mm aft datum  
Main gear: 3303 mm aft datum  
Wing leading edge: 2702 mm aft datum  
Length Mean aerodynamic chord (MAC): 1362 mm

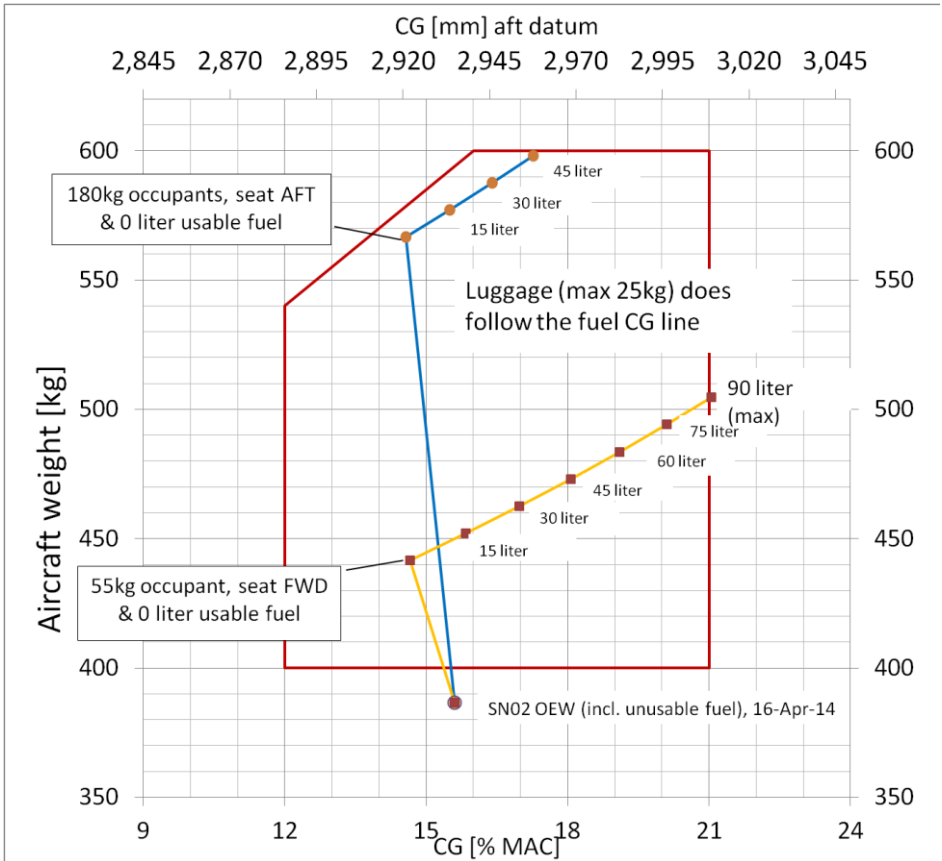

**Figure 3 Approved weight and balance envelope**

The approved flight centre of gravity location is expressed in mm aft datum. Conversion to %MAC is by:

$$\frac{(\text{Station}_{CG} - \text{Station}_{\text{Wing leading edge}})}{\text{Lenght}_{MAC}} * 100\%$$



## 6.2 Weight and balance

### 6.2.1 Actual empty mass

The following table reflects the actual status of empty mass, empty mass centre of gravity and permissible maximum and minimum loading.

The data is compiled from the latest weighing record. Data is only valid for the airplane serial number indicated on the front sheet of this handbook.

Weighing record			
Date	OEW*	Center of gravity	Date and signature
	kg	mm aft datum	
26.10.2017	374.2	2920	25.04.2018, A. Amstutz

\* OEW = operational empty mass contains oil and coolant fluids and unusable fuel

## 6.2.2 Weight and balance determination for flight

To calculate the flight mass and centre of gravity the following station data must be used:

Occupant (seat fwd position)	2830 mm aft datum
Occupant (seat aft position)	2890 mm aft datum
Fuel	3620 mm aft datum
Luggage	3620 mm aft datum

Lever arms for loading are calculated in accordance with the datum.

Prior each flight compliance with permissible loading limits has to be checked with the following calculation:

	Mass m [kg]	Center of gravity CG [mm]	Moment M = m*CG [kg*mm]
Empty	386.6	2934	1134284
+ baggage		3620	
+ pilots seat FWD		2830	
+ pilots seat AFT		2890	
	<b>Σ m</b>	<b>Σ M / Σ m</b>	<b>Σ M</b>
<b>= flight condition, no fuel</b>			-
+ fuel		3620	
	<b>Σ m</b>	<b>Σ M / Σ m</b>	<b>Σ M</b>
<b>= flight condition, with fuel</b> permissible	max 600		-

Both conditions with and without fuel must fall within the approved envelope.

# Weight and balance

# Lightwing AC4



Example calculation (see blue line in Figure 3):

	<b>Mass m [kg]</b>	<b>Center of gravity CG [mm]</b>	<b>Moment M = m*CG [kg*mm]</b>
Empty	386.6	2934	1134284
+ baggage		3620	
+ pilots seat FWD		2830	
+ pilots seat AFT	180	2890	520200
	<b>Σ m</b>	<b>Σ M / Σ m</b>	<b>Σ M</b>
<b>= flight condition, no fuel</b>	566.6	2920	1654484
+ fuel 45liter @0.72kg/liter	32	3620	115840
	<b>Σ m</b>	<b>Σ M / Σ m</b>	<b>Σ M</b>
<b>= flight condition, with fuel</b> permissible	598.6 max 600	2957	1770324

### **6.3 Equipment**

The required functional equipment of the AC4 are

- pneumatic airspeed indicator
- pneumatic altimeter
- magnetic compass
- fuel quantity indicator
- volt/amperemeter
- engine indication system EMU912i EVO
- all primary and secondary controls
- door locking mechanism
- ventilation scoops
- brake system

If any of the above listed is not operational no flight is permitted.

Other equipment must be operational as required by local operation rules, kind of flight and airspace classification:

- COM radio
- Transponder and encoding altimeter

Optional equipment is

- Dynon skyview EFIS
- 12V and 5V power outlets
- Cabin heating system

Any non-operational optional equipment must be disabled during flight.

If an installed cabin heating system is not operational the firewall control valve must be sealed in the closed position.

Consult section 9 of this handbook for potentially retrofitted or modified equipment.



# 7 Aircraft and systems description

- 7.1 Introduction .....64
- 7.2 Airframe .....64
- 7.3 Controls.....64
  - 7.3.1 Elevator control .....65
  - 7.3.2 Aileron control .....65
  - 7.3.3 Rudder control.....65
  - 7.3.4 Flap operation .....65
  - 7.3.5 Elevator trim.....65
  - 7.3.6 Elevator Servo tab.....66
- 7.4 Cockpit/Instrument Panel .....66
- 7.5 Landing gear and brake.....67
- 7.6 Seats and seat belts.....67
- 7.7 Baggage compartment .....68
- 7.8 Powerplant .....68
- 7.9 Fuel system.....70
- 7.10 Electrical system .....73
- 7.11 Pitot/static system .....74
- 7.12 Markings and placards .....74
- 7.13 Avionics.....78
- 7.14 Engine indication.....78
  - 7.14.1 Main Page.....79
  - 7.14.2 Engine data information (INFO) page.....80
  - 7.14.3 System Information (SYST) Page.....81
  - 7.14.4 Flight Data Recording.....82
- 7.15 Cabin heating system.....83

## **7.1 Introduction**

### **7.2 Airframe**

The AC4 structure is a simple design with a central main aluminium tube for the fuselage and tubular frameworks for all the rest. Wings and empennage are strutted. Except for the lifting surface covers and the fuselage aerodynamic shells, all load bearing structure is metal.

The fuselage is constructed around the central load bearing beam. The wing is attached to the centre beam through a cross beam which carries the aluminium and steel tube frame for wing attachment.

The fuselage cross beam also acts as a structural connection for:

- The main landing gear
- Main gear bracing struts
- The wing struts
- The pilot seats
- The outer surface mounting composite bulkhead

The fuselage is covered by composite shells.

The AC4 has a thermal shrinking tensioned fabric skin wing.

Structurally, the wing consists of two aluminium tube spars, held in place by aluminium tube ribs, tensioning cables and a rear lift truss strut combination. The ailerons and high lift devices are fabric covered flat plain flaps and do not contribute to the wing's structural integrity.

The horizontal tail surfaces are attached to the centre beam by bolted connection on side mounted posts. The vertical tail is attached to the centre beam by sleeves penetrating the beam.

### **7.3 Controls**

At cockpit level, the control system consists of a central (single) control stick, two sets of rudder pedals, one flap actuator located at the cockpit ceiling, one elevator trim actuator switch installed on the control stick.



## 7.3.1 Elevator control

Elevators are controlled with push pull rods. Via two gearings at bell cranks, the actuation is delivered at the torsion tube at the leading edge of the elevator, which is just aft of the hinge line of the elevator. The fixed control stop is located at the intermediate bell crank.

## 7.3.2 Aileron control

The ailerons are controlled with a push pull rod and tension cable combination. Control stops are placed on the fuselage centre beam acting at the bell crank connecting the torsion tube to the cables.

## 7.3.3 Rudder control

The rudder is commanded by two sets of rudder pedals connected to control cables. A bell crank connects the cables to the torsion tube placed at the hinge line of the rudder. The pedals are interconnected via the nose gear steering link which makes the rudder control a closed loop system. The fixed control stop is located at the rear end of the fuselage centre beam and limits the travel of the rudder actuation arm.

## 7.3.4 Flap operation

Both flap surfaces are simultaneously moved by means of an electric actuator inside the cockpit. Three flap positions are defined by marks in actuation lever bearing bracket ( $0^{\circ}/10^{\circ}/24^{\circ}$ ). The actuator includes travel limit switches and serves also as travel stop. The actuator lever moves a pair of pushrods, connected to a torsion actuator rod parallel to the flap hinge line. The actuator electric control switch is located in the lower side of the left hand instrument panel to the right of the throttle control.

## 7.3.5 Elevator trim

A trim tab is employed on the left hand elevator side and controlled by an electric actuator. The linear servo is mounted in the elevator, near the hinge line pivot. The control switch is located in the main control stick grip.

## 7.3.6 Elevator Servo tab

A flettner tab is employed on the right hand elevator side and controlled by a push/pull rod fixed to the tail strut.

## 7.4 Cockpit/Instrument Panel

The cockpit is accessible by two upward opening doors. They are latched with two pins actuated by one rotating lever from in or outside. Each door features a fresh air scoop which can be opened by pushing out and adjusted by rotation. Each door further features a map pocket.

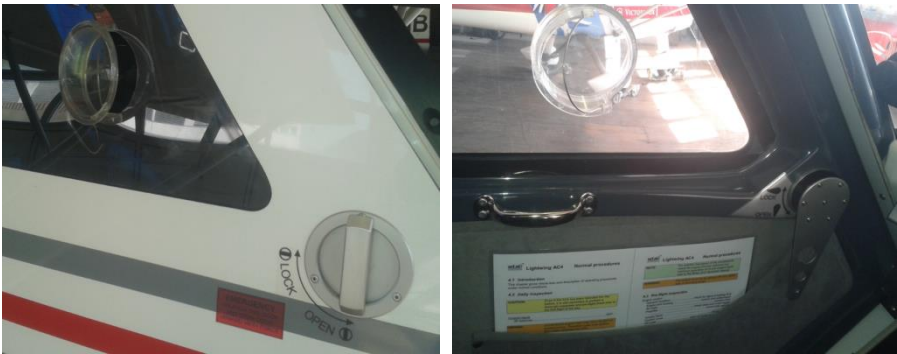

**Figure 7-1 Door lock, air fresh scoop and map storage (inside & outside)**

The instrument panel is depicted in Figure 7-2. It features a glove box on the right side.



Figure 7-2 Cockpit instrument panel

## 7.5 Landing gear and brake

The AC4 has a tricycle landing gear with a steerable nose wheel. The nose gear leg passes through the entire fuselage centre beam. An elastomeric insert is used to provide the spring/damping characteristics of the nose gear. Nose wheel steering rotation is actuated by a direct connection to the rudder pedals using pushrods. The pushrods feature a fire sleeve protection at the firewall penetration. The main landing gear leg is a machined steel flat spring connected by brackets to the fuselage cross beam. Central braking is present at the main gear wheels, using floating disk brakes, actuated by a single break handle placed on the main control stick. The brake handle incorporates the brake fluid reservoir. Fluid filling control is given by the adjustment travel length of the brake lever.

## 7.6 Seats and seat belts

Two seats with integrated head rest, with an adjusting range of approx. 6 cm are provided. The adjustment can be done only on ground. For the adjustment two quick pins must be removed and reinstalled on each seat. The seat is structurally supported by a forward extending framework attached to the main cross beam and a secondary fuselage cross beam forward of the seat. 3 point seat belts are anchored below the seat pan and the wing support frame.

## 7.7 Baggage compartment

A maximum of 25kg of baggage can be placed behind the seats, above the fuel tank, and can be secured by rings anchored at the fuselage main beam and the frame aft of the doors

The fuel cell top surface cover is sized as loading bay to withstand maximum baggage mass g-loads and according impacts (baggage drop during loading).

## 7.8 Powerplant

In this document only the essential basics to understand the engine function is presented. In any case the pilot shall be familiar with the operation manual of the engine which is delivered with the airplane.

The AC4 powerplant consists of the fuel injected Rotax 912iSc/iS Sport engine and a fixed pitch propeller type CR3-75 3-blade. The engine is air and liquid cooled.

The powerplant is accessible after removing the top and bottom engine cowlings.

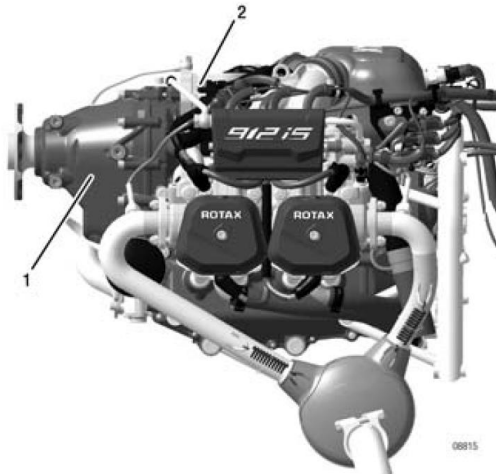

**Figure 7-3 Engine left side view**

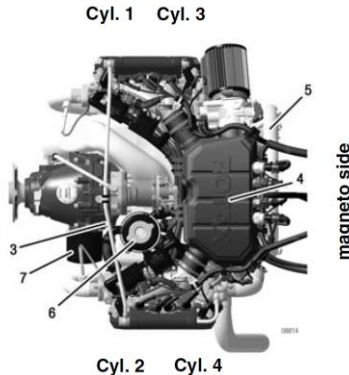

**Figure 7-4 Engine top view**

In Figure 7-4 the engine serial number (3), airbox (4), electric starter (5), expansion tank (6) and oil filter (7) arrangements are shown, together with cylinder numbers.

Direction of rotation on propeller shaft is clockwise, looking from the pilot seat.

The ROTAX 912iSc/iS Sport is equipped with an electronic guided dual ignition unit using 4 double ignition coils with integrated generator. A digital engine control unit (ECU) generates and processes the ignition and fuel injection signal electronically. The system enables highly accurate metering of the fuel according to operating and load conditions, whilst at the same time also taking ambient conditions into account. The key input variables are throttle valve position, engine speed signal, intake air temperature, ambient pressure, boost pressure and exhaust temperature. Ultimately, the required fuel quantity or injection period is determined on the basis of the calculated air density in the airbox. It is monitored continuously.

The ECU contains LANE A and LANE B in a single housing. In principle each LANE represents an independent computer. In the "AUTO" mode (Engine key on position Lane A/B) setting, the ECU decides which LANE takes control (redundancy management).

There are two individual LANE warning lights. Any one flashing indicates a situation where flight operation is limited (no take off). Any one permanently on indicates a situation where a precautionary landing should be made. The warning light is also permanently on when only one LANE is selected by the engine key switch.

If the engine power supply (Alternator A) fails the system automatically switches one-time over to the second power supply (Alternator B). In this condition there is no supply to the airframe and no battery charging. While alternator B runs, no power drop is recognizable. Failure of both power supplies result in engine stoppage. Remedy: Switch "ON" the backup battery switch. In this case the power supply is provided by the aircraft battery. Land the aircraft at the next available opportunity. A maintenance inspection should be carried out.

## 7.9 Fuel system

Fuel is stored in a single composite fuel tank behind the seats. The tank capacity is 94 liter of which 4 liter are unusable. On the tank bottom, leaving a sump volume below, bulkhead penetrations and a fuel strainer are mounted. A separate unit with fuel filter, and the fuel injection pumps unit is mounted below the centre beam, in front of the fuselage cross beam. The fuel tank further has a drain valve and connections for the return line, an opening for a capacitive sensor and the filling connection (Figure 7-7).

**CAUTION:**

The fuel quantity indicator is no substitute for pre-flight fuel management. Use the sight gauge only. The fuel indicator shows zero at 4 liter actual content (unusable fuel) and full at approximately 90 liter.

The fuel indicator has a spread giving significant more needle movement towards low fuel states.

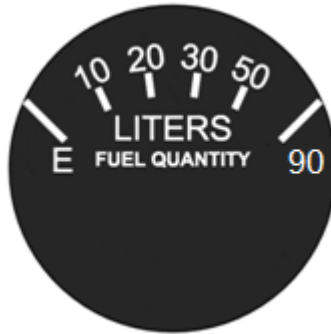

Figure 7-5 Fuel quantity indicator

**CAUTION:**

It should be avoided to overfill fuel. The hose from the filler neck to the fuel tank should not be submerged.

The filler neck is located on the left hand empennage cover. A sight gauge is installed aft of the co-pilot seat.

The system can be drained through the tank. A (water) contamination collection sump is present in the lower part of the tank. Just above is a 4 litre header volume to ensure uninterrupted fuel supply.

No valve, sensor or other intermediate element is employed downstream of the fuel pump unit except a fuel fine filter located in the engine compartment. This part of the system, during operation is pressurized at 3 bar.

A low fuel warning is installed using an optical sensor in the fuel sump. Its nominal trigger point is just above the unusable fuel quantity.

The low fuel warning light is installed just below the fuel QTY indicator.

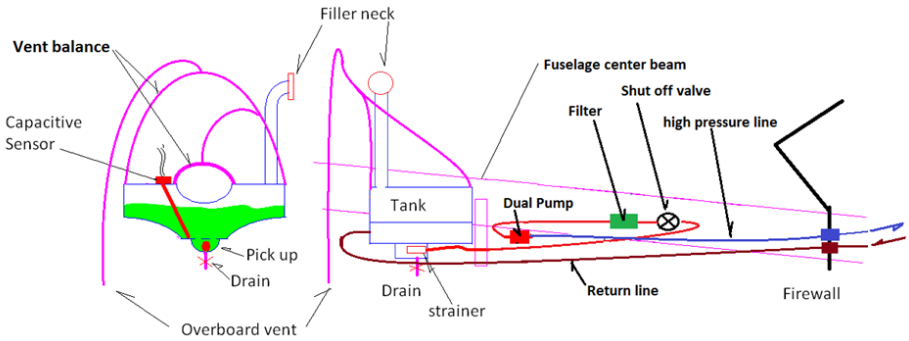

**Figure 7-6 Fuel storage system**

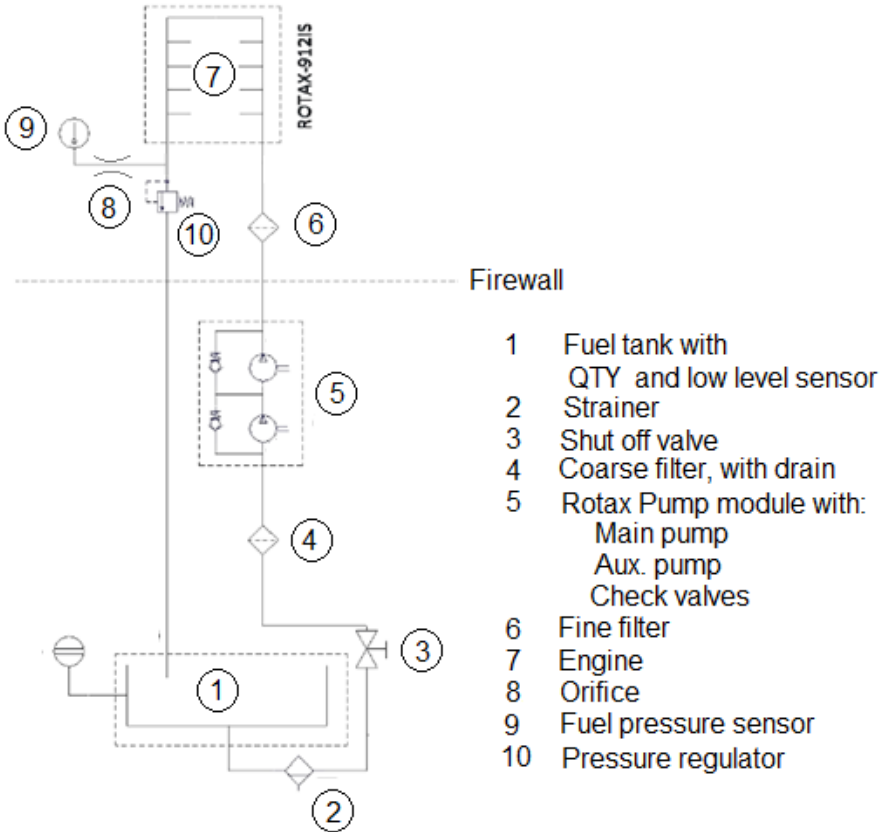

**Figure 7-7 Engine fuel system**



### 7.10 Electrical system

The heart of the system is provided by the fuse box of the engine manufacturer. The Rotax generation system provides a 12/14 V system voltage. On the airframe side it further features a lead battery located in the engine compartment, with a 12 Ah capacity at 12.7 V. Control switches, indicators and distribution busses are provided.

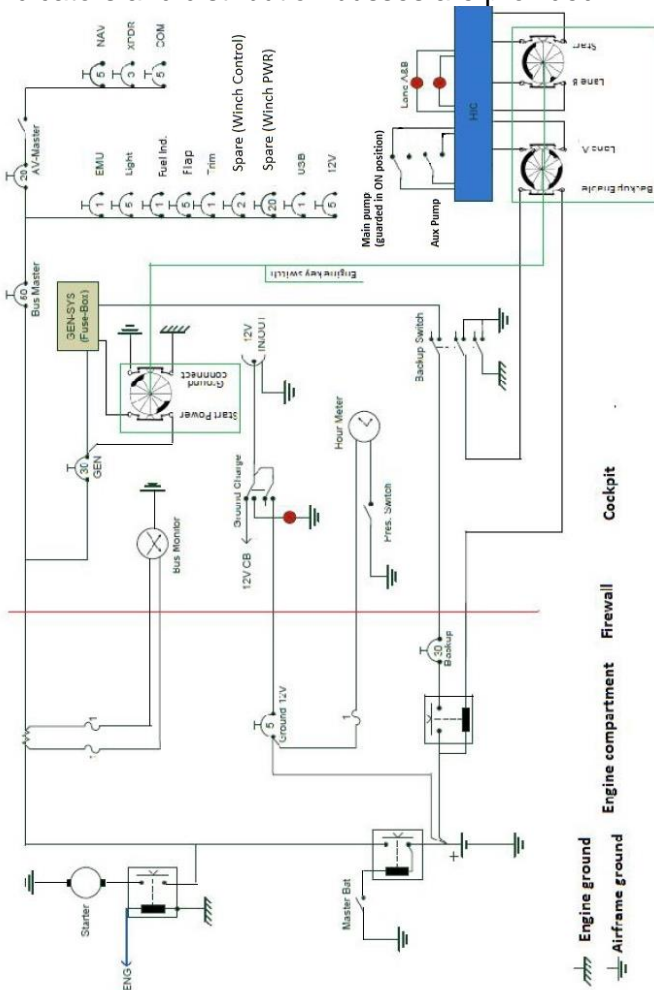

Figure 7-8 Electrical system schematic

## 7.11 Pitot/static system

The pitot port is located in the left wing, at the connection of the wing strut. It is routed through the wing, then along the fuselage frame to the centre of the instrument panel. Static pressure is taken from the interior of the fuselage and routed to the instrument panel along the fuselage centre beam. The drain of the pitot and the static lines are located under the co-pilot seat.

Pitot and static pressure serve the primary airspeed and altitude indication (analog instruments) and the Dynon Skyview system. Pitot pressure is further used to trigger the engine hour logging when forward speed is given. Static pressure is further routed to the encoding altimeter.

The Dynon Skyview system is a secondary system which does not carry ETSO approval. In case the indications of primary and secondary system deviate the flight should be continued on the primary instruments and terminated as soon as practical. To determine if the secondary or primary (or both) systems are erroneous select a dedicated power setting in level flight and compare the achieved indicated airspeed with handbook data presented in section 5.3.1.

## 7.12 Markings and placards

In addition to the markings and placards given in chapter 2.15 the following markings placards are installed (placards not to scale):

Flap Switch:



Flap Indication (overhead):



Main Electric switch row:

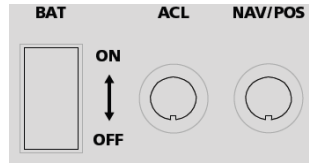

Engine control:

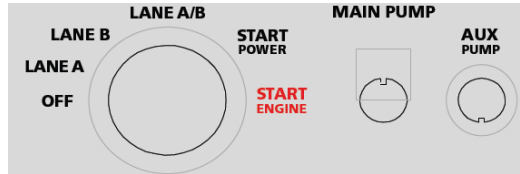

Avionics (radio) master & Back-Up switch:

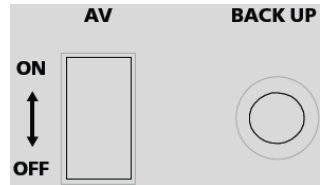

Circuit breakers: GEN / MASTER / AV MASTER / 12V OUT / USB  
FLAPS / TRIM / LIGHTS / EMU  
COM / XPDR / NAV / FLARM

Circuit breakers in engine compartment: BACK-UP

Left side Instrument panel:

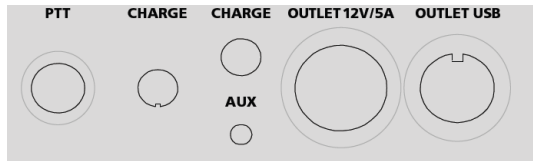

Trim Indication (T/O = takeoff):



Fuel valve:

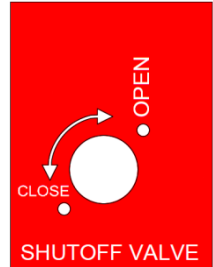

Cabin heat control:

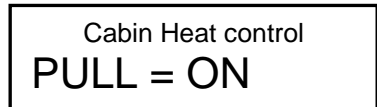

Deviation placard, compass:

AIRCRAFT DEVIATION <i>calibration with receivers on</i>					
For	Steer	For	Steer	For	Steer
N		30		60	
E		120		150	
S		210		240	
W		300		330	

Date: .....

Door left and right, inside:

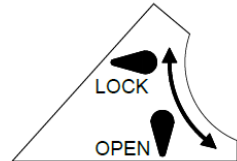

Door left and right, outside:

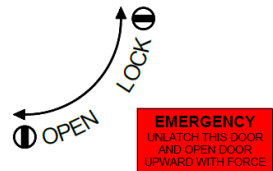

*Right side accordingly mirrored*

Baggage compartment:

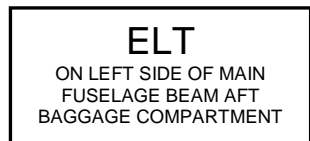
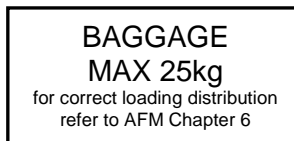

Coolant reservoir:

## Coolant

50% BASF Glysantine Protect G48,  
50% distilled water;  
other grades ref. Rotax SI-912i-001

Oil reservoir :

## OIL: 3 Liters

Hight performance motorcycle oil with  
gear additive API classification "SG" or  
higher, for other see Rotax-SI-912i-001

Fuselage, filler neck:

USABLE FUEL 90 LITERS

## Mogas/Avgas

Min. 95 RON/ROZ, EN 228  
for other grades refer to AFM

Main landing gear:

Main wheel tire pressure

**3.0 bar / 44 PSI**

Nose landing gear:

Nose wheel tire pressure

**2.7 bar / 39 PSI**

## **7.13 Avionics**

The avionic units of the AC4 are powered via the radio-bus which has a separate circuit breaker and is controlled by the "Avionic master" switch.

The (optional) ELT is installed on the left side of the main fuselage bean behind the baggage compartment. The respective antenna is located on top of the tail fuselage cover. The remote control switch is installed in the instrument panel next to the trim indication.

For further information about the operation of the installed units refer to relevant manufacturer documentation supplied with the aircraft.

The Dynon Skyview EFIS system is Lightwing factory programmed for correct units and limits, colour codes etc. The configuration software is locked. Data base updates must be installed in intervals. Software updates are published by Light Wing AG service bulletins and are installed at approved stations. The Dynon Skyview system does emit sounds into the COM-systems to provide warnings, related to speeds, terrain, traffic, etc.

The Dynon Skyview system is a secondary system which does not carry ETSO approval. In case the indications of primary and secondary system deviate the flight should be continued on the primary instruments and terminated as soon as practical. To determine if the secondary or primary (or both) systems are erroneous select a dedicated power setting in level flight and compare the achieved indicated airspeed with handbook data presented in section 5.3.1. Instructions and information regarding the EFIS system technology and its operation are contained in the Skyview user manual.

The Lightwing AC4 is equipped with a PowerFLARM, which is indicated within the Skyview EFIS. Instructions and information regarding this system technology and its operation are contained in the relevant PowerFlarm description documents, information regarding the indication to the pilot are contained in the Skyview user manual. PowerFLARM updates of firmware and database is performed during scheduled maintenance

## 7.14 Engine indication

A Stock flight EMU912iS evo is employed on the AC4. It indicates all engine parameters, but no fuel quantity. The software for the EMU is installed in production and locked. Software updates might be mandated or recommended by Light Wing AG through service bulletins and are uploaded by approved stations.

The unit is controlled by a number of panel mounted controls which change function depending on the selected page, see Figure 7-9.

The EMU912iS evo indication is powered by the main bus and is activated with the battery master switch. The boot cycle requires about 10sec after with the main screen is displayed. Actual indications after boot up are limited. Only with active lanes of the engine all parameters are displayed.

Rotating the brightness potentiometer (BRT) adjusts the screen brightness. After power on the initial brightness is maximum.

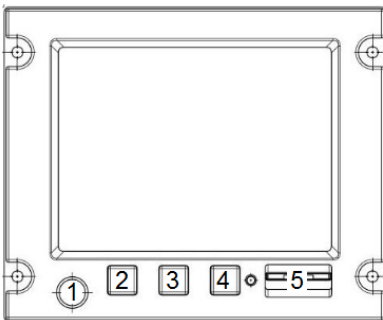

- 1 Brightness knob BRT  
Master caution reset button MCR  
return button
- 2 INFO page select
- 2,3 Page up-down softkey
- 4 ZERO button, active only on INFO page
- 5 SD-Card slot

Figure 7-9 EMU912iS evo panel controls

### 7.14.1 Main Page

The main page displaying all parameters relevant for the engine operation is shown in Figure 7-10.



Figure 7-10 EMU912iS main display page

The colour of the main page text information changes automatically according to the limit definitions as set forth in chapter 2.5. The squares labelled "A" and "B" indicate the status of the ECU lanes. The colour of the squares changes with the error status of the corresponding ECU lane (green/red/white). This is also indicated through the corresponding text (i.e. "A:SBY" or "B:ACT"). In case of sensor failure, the display of the associated signal will revert to dashes ("---") to immediately indicate the failure situation. The central warning area displays informational messages when engine parameters are out of range. Messages displayed in the central warning area will automatically disappear when back in range or disappear when confirmed by pressing the "MCR" (Master Caution Reset) button. The display units correspond to the units used throughout this handbook.

## 7.14.2 Engine data information (INFO) page

The Engine Data Information page (INFO) is selected by pressing the INFO softkey. It displays selected engine data in parameter groups using coloured bars indicating the current values and the associated operational warnings and limits. The desired parameter group may be



selected using the up/down softkeys. The selected parameter group is depicted on a green background.

An example for the layout of the INFO page is shown in Figure 7-11

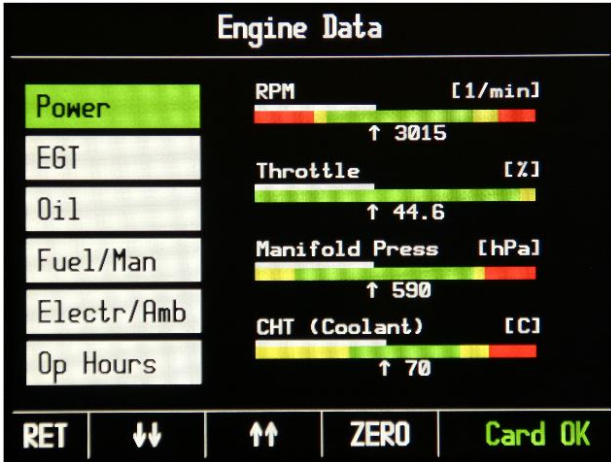

Figure 7-11 Example INFO display page

The various engine parameter groups may be selected using the up/down buttons. Each parameter has its own drag indicator (white horizontal lines on top). The drag indicators for each parameter group may be reset at any time through the ZERO button. Pressing the RET button brings up the MAIN page regardless of the currently selected parameter group.

### 7.14.3 System Information (SYST) Page

The system information page (SYST) provides six subpages for warnings, ECU faults, the status of the ECU lanes, the ECU configuration, the status of the EMU912iS evo flight data recording function and a CAN aerospace bus monitor. The desired status information subpage may be selected using the up/down softkeys. The selected information group is depicted on an amber background (Warnings and ECU Faults) or a green background (all others). Pressing the RET button brings up the MAIN page regardless of other selections. An example of the SYST subpages is shown in Figure 7-12.

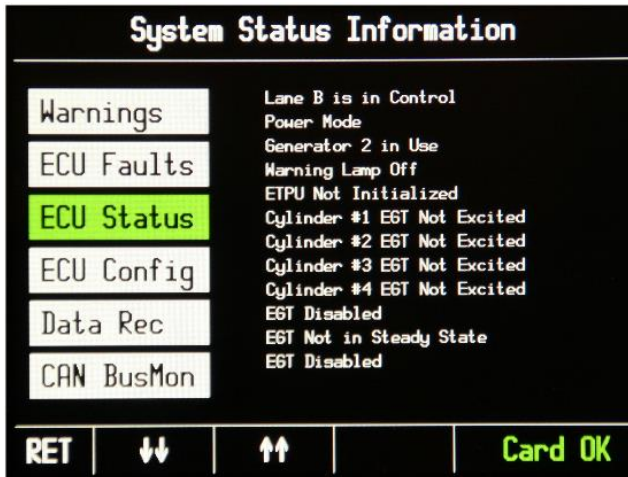

Figure 7-12 Example System Status Information

## 7.14.4 Flight Data Recording

The EMU 912iS evo provides data recording of all data transmitted by the ECU. The data is stored on the SDHC card. For each restart of the EMU and after intervals of 30min, a new data file of arbitrary length is created and the previous one is closed. The file naming convention is: DAT\_wxyz.CAN

where "wxyz" is the decimal file number, which is incremented by one for each new file and allows 9999 different files to be created, named and stored. The number of the last file which has been closed and written to the SDHC card is stored as a 4-character ASCII string in the file "TOPDAT.CFG" which is also written to the card. The EMU 912iS evo records all data of both ECU data bus lanes (12 kbytes/s). Most of the data is transmitted 10 times per second. Using a 16GB SDHC memory card, this results in a maximum recording time of 280 hours. An Engine Management Debriefing Station (EMDS) software to visualize the data is available from Stock Flight systems.

## 7.15 Cabin heating system

The AC4 features an optional cabin heating system which uses RAM air aft of the coolant radiator and guides it through an exhaust shroud. The heated air is further guided to a firewall mounted valve which either dumps the air back into the cowling area or, if the valve is selected by the pilot to ON, into the cabin below the instrument panel. The cabin control for this function is located on the centre pedestal below the instrument panel. Its function is “PULL” for cabin heating active and “PUSH” for cabin heating off.

In the OFF position the valve at the firewall must be fully and tightly closed. It is visible underneath the instrument panel, see Figure 7-14

Whenever the cowling is removed, it is good practice to inspect the tight fit of the air duct tapping downstream of the radiator (Figure 7-13) and the radiator for signs of chafing, as well as the heat shroud and exhaust for any damage or deterioration. The most important item to avoid lethal CO contamination is to ensure positive (RAM air) pressure inside the system. Therefore the correct and tight fit of the air duct to the radiator shall be given special attention.

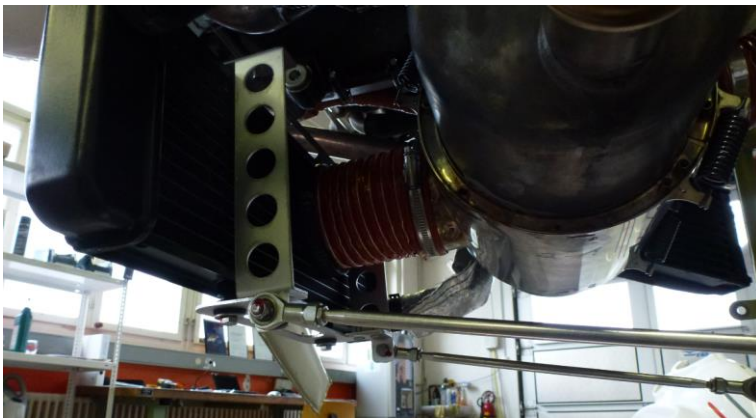

**Figure 7-13 Cabin heating air source at radiator**

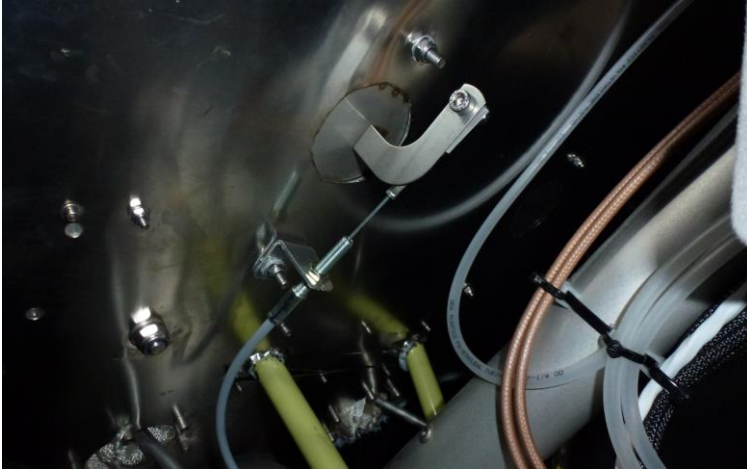

**Figure 7-14 Cabin heating valve at firewall, cabin side**

## 8 Handling and maintenance

### 8.1 Introduction

This chapter provides information to the pilot relevant for maintaining the airplane in airworthy and good performing conditions.

<b>Note:</b>	Any work performed on the airplane by the pilot, except for general cleaning, should be noted in the airplane logbook.
--------------	--

It is important that the pilots knows and adheres to the definitions what kind of work he may execute himself and which type of work has to be executed within approved maintenance stations. Those definitions vary among various countries. Definitions given in this handbook are a guideline.

It is further important that the pilot knows the recommended and mandatory inspection periods and initiates their execution within approved stations in a timely manner.

The pilot shall note in the airplane log book any problem encountered or any suspected problem to make sure the respective information is transported to the maintenance personal for corrective actions. Problems requiring immediate action, such as heavy landing overload or prop strike shall be marked accordingly. Consider to leave an “aircraft out of order” cockpit note. It is required that pilot reviews the airplane logbook after maintenance action to determine if his entries have been taken care of.

## ***8.2 Airplane inspection periods***

All recommended and mandatory inspections, except for the pre-flight inspection must be executed by authorized personal. The maintenance manual LW-RL-Z-004 defines the relevant programs for scheduled inspection and maintenance.

The AC4 scheduled inspection and maintenance program comprises:

- Non repetitive aircraft inspection at 25hours after delivery of the aircraft.
- Break-in inspection and maintenance of a new powerplant at 25 engine hours in accordance with applicable engine manufacturer publications.
- Recommended repetitive 50h powerplant inspection
- Repetitive mandatory 100 hour aircraft (powerplant and airframe) inspection or annual inspection, whichever comes first.
- A repetitive 2000hour/10year, whichever comes first, major engine mount inspection/maintenance program
- A repetitive 3000hour/10year, whichever comes first, major airframe inspection/maintenance program.

## ***8.3 Airplane alterations and repair***

Required alterations are published in Service Bulletins along with instructions for the alteration. This includes alterations in this flight manual.

Any other alteration of the airplane must be approved by the regulating authority and be either based on a “one off” modification (major or minor change) or an according supplemental type certificate issued by a respective design organization.

Alterations with respect to additional equipment, as far as included in the type definition must be executed in accordance with Light Wing AG installation instructions.

Repair, except small scale touch up paint and other cosmetic issues, must be executed in accordance with the maintenance manual LW-RL-Z-004, which includes general repair instructions. Repair beyond these general instructions require approved repair instructions.

## 8.4 Ground handling

Ground handling shall be done with care.

Do not:

- push at wing tips
- pull at propeller tips
- push at control surfaces
- keep park brake set without reason

Do:

- lower the tail to raise nose gear for tight corner movements
- leave door open in hangar if airplane is moist from rain
- leave fuel selector open for better detection of leaks
- hold doors tight in wind conditions

Tie down:

- Apply soft and wide straps around wing struts at strut to wing interface.

<b>Caution:</b>	Any disassembly (wings, horizontal stabilizer) which could be convenient for hangar storage is work to be executed by licensed personnel only.
-----------------	--

## 8.5 *Cleaning and care*

The composite surface is protected with a polyester gel coat. For cleaning those and the aerodynamic lifting surfaces covers use any car cleaning detergent. Insect removal detergents should be used as little as possible. Avoid that this sort of cleaners dries on the surface. Oil traces can be removed with white sprit or AVGAS.

The transparencies are made from polycarbonate. Any cleaning, polishing etc. has to be executed with utmost care to avoid cracks and scratches. Use a soft and clean cotton cloth. In case cracks develop it is recommended to drill a 3mm hole at the crack end to stop crack propagation.

**Caution:**

The windshield transparency is under significant aerodynamic pressure in flight. Cracks must be repaired prior next flight. This work must be executed by licensed personnel only.

For cleaning of the transparency do not use fuel or other aggressive media.