



GNC 255A/255B

Pilot's Guide



© 2012 Garmin Ltd. or its subsidiaries. All rights reserved.

This manual reflects the operation of System Software version 2.00, or later. Some differences in operation may be observed when comparing the information in this manual to later software versions.

Garmin International, Inc., 1200 East 151st Street, Olathe, KS 66062, U.S.A.

Tel: 913/397.8200

Fax: 913/397.8282

Garmin AT, Inc., 2345 Turner Road SE, Salem, OR 97302, U.S.A.

Tel: 503/391.3411

Fax 503/364.2138

Garmin (Europe) Ltd., Liberty House, Bulls Copse Road, Hounslow Business Park, Southampton, SO40 9RB, U.K.

Tel. +44 (0) 870 850 1243

Fax +44 (0) 238 052 4004

Garmin Corporation, No. 68, Zhangshu 2nd Road, Xizhi Dist., New Taipei City 221, Taiwan (R.O.C.)

Tel: 886/02.2642.9199

Fax: 886/02.2642.9099

Garmin Singapore Pte. Ltd., 46 East Coast Road, #05-06 Eastgate, Singapore 428766

Tel : (65) 63480378

Fax : (65) 63480278

At Garmin, we value your opinion. For comments about this guide, please e-mail:

Techpubs.Salem@Garmin.com

www.garmin.com

<https://fly.garmin.com/fly-garmin>

Except as expressly provided herein, no part of this manual may be reproduced, copied, transmitted, disseminated, downloaded or stored in any storage medium, for any purpose without the express written permission of Garmin. Garmin hereby grants permission to download a single copy of this manual and of any revision to this manual onto a hard drive or other electronic storage medium to be viewed for personal use, provided that such electronic or printed copy of this manual or revision must contain the complete text of this copyright notice and provided further that any unauthorized commercial distribution of this manual or any revision hereto is strictly prohibited.

This part shall comply with Garmin Banned and Restricted Substances document, 001-00211-00.

Garmin® is a registered trademarks of Garmin Ltd. or its subsidiaries. These trademarks may not be used without the express permission of Garmin.



LIMITED WARRANTY

All Garmin avionics products are warranted to be free from defects in materials or workmanship for: two years from the date of purchase for new Remote-Mount and Panel-Mount products; one year from the date of purchase for new portable products and any purchased newly-overhauled products; six months for newly-overhauled products exchanged through a Garmin Authorized Service Center; and 90 days for factory repaired or newly-overhauled products exchanged at Garmin in lieu of repair. Within the applicable period, Garmin will, at its sole option, repair or replace any components that fail in normal use. Such repairs or replacement will be made at no charge to the customer for parts or labor, provided that the customer shall be responsible for any transportation cost. This warranty does not apply to: (i) cosmetic damage, such as scratches, nicks and dents; (ii) consumable parts, such as batteries, unless product damage has occurred due to a defect in materials or workmanship; (iii) damage caused by accident, abuse, misuse, water, flood, fire, or other acts of nature or external causes; (iv) damage caused by service performed by anyone who is not an authorized service provider of Garmin; or (v) damage to a product that has been modified or altered without the written permission of Garmin. In addition, Garmin reserves the right to refuse warranty claims against products or services that are obtained and/or used in contravention of the laws of any country.

THE WARRANTIES AND REMEDIES CONTAINED HEREIN ARE EXCLUSIVE AND IN LIEU OF ALL OTHER WARRANTIES, WHETHER EXPRESS, IMPLIED OR STATUTORY, INCLUDING ANY LIABILITY ARISING UNDER ANY WARRANTY OF MERCHANTABILITY OR FITNESS FOR A PARTICULAR PURPOSE, STATUTORY OR OTHERWISE. THIS WARRANTY GIVES YOU SPECIFIC LEGAL RIGHTS, WHICH MAY VARY FROM STATE TO STATE.

IN NO EVENT SHALL GARMIN BE LIABLE FOR ANY INCIDENTAL, SPECIAL, INDIRECT OR CONSEQUENTIAL DAMAGES, WHETHER RESULTING FROM THE USE, MISUSE OR INABILITY TO USE THE PRODUCT OR FROM DEFECTS IN THE PRODUCT. SOME STATES DO NOT ALLOW THE EXCLUSION OF INCIDENTAL OR CONSEQUENTIAL DAMAGES, SO THE ABOVE LIMITATIONS MAY NOT APPLY TO YOU.

Garmin retains the exclusive right to repair or replace (with a new or newly-overhauled replacement product) the product or software or offer a full refund of the purchase price at its sole discretion. SUCH REMEDY SHALL BE YOUR SOLE AND EXCLUSIVE REMEDY FOR ANY BREACH OF WARRANTY.

Online Auction Purchases: Products purchased through online auctions are not eligible for warranty coverage. Online auction confirmations are not accepted for warranty verification. To obtain warranty service, an original or copy of the sales receipt from the original retailer is required. Garmin will not replace missing components from any package purchased through an online auction.

International Purchases: A separate warranty may be provided by international distributors for devices purchased outside the United States depending on the country. If applicable, this warranty is provided by the local in-country distributor and this distributor provides local service for your device. Distributor warranties are only valid in the area of intended distribution. Devices purchased in the United States or Canada must be returned to the Garmin service center in the United Kingdom, the United States, Canada, or Taiwan for service.

To obtain warranty service, contact your local Garmin Authorized Service Center. For assistance in locating a Service Center near you, visit the Garmin web site at <http://www.garmin.com> or contact Garmin Customer Service at 866-739-5687.



WARNING: For safety reasons, GNC 255 operational procedures must be learned on the ground.



CAUTION: The Garmin GNC 255 does not contain any user-serviceable parts. Repairs should only be made by an authorized Garmin service center. Unauthorized repairs or modifications could void both the warranty and the pilot's authority to operate this device under FAA/FCC regulations.



CAUTION: The GNC 255 display uses a lens coated with a special anti-reflective coating that is very sensitive to skin oils, waxes, and abrasive cleaners. **CLEANERS CONTAINING AMMONIA WILL HARM THE ANTI-REFLECTIVE COATING.** It is very important to clean the lens using a clean, lint-free cloth and an eyeglass lens cleaner that is specified as safe for anti-reflective coatings.



NOTE: Garmin recommends that if flying in a region with 8.33 kHz COM channel spacing, the radio should remain in 8.33 kHz mode. This will prevent the loss of stored user and recent frequencies.



NOTE: Do not use outdated database information. Databases used in the system must be updated regularly in order to ensure that the information remains current. Pilots using an outdated database do so entirely at their own risk.



NOTE: All visual depictions contained within this document, including screen images of the GNC 255 bezel and displays, are subject to change and may not reflect the most current GNC 255 software. Depictions of equipment may differ slightly from the actual equipment.



NOTE: This device complies with part 15 of the FCC Rules. Operation is subject to the following two conditions: (1) this device may not cause harmful interference, and (2) this device must accept any interference received, including interference that may cause undesired operation.



NOTE: This product, its packaging, and its components contain chemicals known to the State of California to cause cancer, birth defects, or reproductive harm. This notice is being provided in accordance with California's Proposition 65. If you have any questions or would like additional information, please refer to our web site at www.garmin.com/prop65.



NOTE: *Canadian installations: In accordance with Canadian Radio Specifications Standard 102 (RSS 102), RF field strength exposure to persons from an antenna connected to this device should be limited to 60 V/m for controlled environment and 28 V/m for uncontrolled environment.*

NOTE: This device complies with Part 15 of the FCC limits for Class B digital devices. This equipment generates, uses, and can radiate radio frequency energy and, if not installed and used in accordance with the instructions, may cause harmful interference to radio communications. Furthermore, there is no guarantee that interference will not occur in a particular installation.

If this equipment does cause harmful interference, the user is encouraged to try to correct the interference by relocating the equipment or connecting the equipment to a different circuit than the affected equipment. Consult an authorized dealer or other qualified avionics technician for additional help if these remedies do not correct the problem.

Operation of this device is subject to the following conditions: (1) This device may not cause harmful interference, and (2) this device must accept any interference received, including interference that may cause undesired operation.

To obtain accessories for your unit, please contact your Garmin dealer.

Help us better support you by completing our on-line registration form today! Registration ensures that you will be notified of product updates and new products and provides lost or stolen unit tracking. Please, have the serial number of your unit handy, connect to our web site (www.garmin.com) and look for our Product Registration link on the Home page.

The display surface is coated with a special anti-reflective coating which is very sensitive to skin oils, waxes and abrasive cleaners. It is very important to clean the lens using an eyeglass lens cleaner which is specified as safe for anti-reflective coatings and a clean, lint-free cloth.

Product Registration and Support

Help us better support you by completing your online registration today! Have the serial number of your product handy and connect to the Garmin web site (www.garmin.com or <https://fly.garmin.com/fly-garmin>). Look for the Product Registration link on the Home page. Also, be sure to record your serial number in the space provided.

If you have any questions, the Garmin Product Support department may be reached Monday through Friday, 7:00 AM to 7:00 PM Central Time.

US: 913-397-8200

US Toll Free: 1-866-739-5687

Canada Toll Free: 1-866-429-9296

| Record of Revisions | | | |
|----------------------------|-----------------|-------------|--------------------|
| Part Number | Revision | Date | Description |
| 190-01182-01 | A | 11/19/12 | Initial release |

Contents

| | |
|--|------------|
| Product Registration and Support | v |
| 1 Getting Started | 1-1 |
| 1.1 Product Description | 1-1 |
| 1.2 Pilot Controls | 1-2 |
| 1.2.1 Power/Com Volume/Squelch Knob | 1-2 |
| 1.2.2 Nav Volume/ID Knob | 1-2 |
| 1.2.3 Tuning LARGE/SMALL Concentric (Cursor) Knobs | 1-3 |
| 1.2.4 FLIP/FLOP Key | 1-3 |
| 1.2.5 C/N (Com/Nav) Key | 1-3 |
| 1.2.6 OBS Key | 1-3 |
| 1.2.7 T/F (To/From) Key | 1-3 |
| 1.2.8 CLR (Clear) Key | 1-3 |
| 1.2.9 ENT (Enter) Key | 1-3 |
| 1.2.10 FUNC (Function) Key | 1-4 |
| 1.2.11 MON (Monitor) Key | 1-4 |
| 1.3 USB Port | 1-4 |
| 2 Basic Operation | 2-1 |
| 2.1 Power On | 2-1 |
| 2.2 Com Radio | 2-1 |
| 2.2.1 Selecting a Com Frequency | 2-1 |
| 2.2.2 Monitoring the Standby Com Channel | 2-2 |
| 2.2.3 Saving a Com Channel | 2-2 |
| 2.2.4 Com Database Look-Up | 2-4 |
| 2.2.5 Frequency Database Reverse Look-Up | 2-4 |
| 2.2.6 Emergency Channel | 2-5 |
| 2.2.7 Stuck Mic | 2-5 |
| 2.2.8 Remote Frequency Selection Control | 2-5 |
| 2.3 Nav Radio | 2-6 |
| 2.3.1 Selecting a Nav Frequency | 2-6 |
| 2.3.2 Saving a Nav Channel | 2-6 |
| 2.3.3 Listening to the Nav Audio Channel | 2-7 |
| 2.4 OBS Mode | 2-8 |
| 2.5 Distance/Speed/Time (DST) Display | 2-9 |

| | | |
|----------|--|------------|
| 3 | Functions..... | 3-1 |
| 3.1 | Functions Description..... | 3-1 |
| 3.2 | Com Frequencies | 3-2 |
| 3.2.1 | Recent Com Frequencies..... | 3-2 |
| 3.2.2 | Com User Frequencies | 3-3 |
| 3.2.2.1 | Viewing the Com User Frequency..... | 3-3 |
| 3.2.2.2 | Deleting the Com User Frequency | 3-3 |
| 3.2.2.3 | Editing a Com User Frequency | 3-4 |
| 3.2.3 | Com Database Frequencies..... | 3-5 |
| 3.2.4 | Com Nearest Airports (APT)..... | 3-6 |
| 3.2.5 | Com Nearest Area Control Center (ACC) Frequencies | 3-7 |
| 3.2.6 | Com Nearest Flight Service Station (FSS) Frequencies | 3-8 |
| 3.2.7 | Com Nearest Weather (WX) Frequencies | 3-9 |
| 3.3 | Nav Frequencies | 3-10 |
| 3.3.1 | Recent Nav Frequencies..... | 3-10 |
| 3.3.2 | Nav User Frequencies | 3-11 |
| 3.3.2.1 | Viewing the Nav User Frequency..... | 3-11 |
| 3.3.2.2 | Deleting the Nav User Frequency | 3-11 |
| 3.3.2.3 | Editing a Nav User Frequency | 3-12 |
| 3.3.3 | Nav Database Frequencies..... | 3-13 |
| 3.3.4 | Nav Nearest VOR..... | 3-14 |
| 3.4 | ICS Configuration | 3-15 |
| 3.4.1 | Adjust Intercom..... | 3-15 |
| 3.4.2 | Aux Audio | 3-16 |
| 3.4.3 | Intercom On/Off | 3-17 |
| 3.4.4 | Speaker On/Off..... | 3-17 |
| 3.5 | System Configuration..... | 3-18 |
| 3.5.1 | Com Spacing..... | 3-18 |
| 3.5.2 | Display Brightness | 3-19 |
| 3.5.3 | Display Contrast | 3-20 |
| 3.5.4 | Database Info..... | 3-20 |
| 3.5.5 | Load Database | 3-21 |
| 3.5.6 | Software Version | 3-22 |
| 3.5.7 | Serial Number | 3-22 |
| 3.6 | Timers | 3-23 |
| 3.6.1 | Setting Up the Count Down Timer..... | 3-23 |
| 3.6.2 | Setting Up the Count Up Timer | 3-24 |

- 3.6.3 Viewing Timers in the Com Display..... 3-24
- 4 Appendix.....4-1**
- 4.1 Troubleshooting..... 4-1
- 4.2 Updating the Frequency Database 4-3
 - 4.2.1 Downloading the Frequency Database 4-3
 - 4.2.2 Updating the GNC 255 Frequency Database 4-3
- 4.3 Messages 4-4
- Index.....Index-1**

This page intentionally left blank

1 GETTING STARTED

1.1 Product Description

Combining a powerful VHF communications transceiver with 200 channel VOR, Localizer and Glideslope receivers, the GNC 255 provides a full-functioned navigation and communications solution in a small footprint at a very affordable price. Besides traditional Nav/Com features, the GNC 255 also incorporates workload-reducing functions such as automatic decoding of the Morse code station identifier for VOR/LOC, most-used frequency storage in memory, built-in course deviation indicator, and more.

The GNC 255 has the ability to monitor the standby Com frequencies. The GNC 255's Com radio operates in the aviation voice band, from 118.000 to 136.975 MHz, in 25 kHz steps (default). For European operations, a Com radio configuration of 8.33 kHz steps is also available. The GNC 255 VHF Nav receiver operates from 108 MHz to 117.95 MHz decoding both the VHF Omni Range and Localizer navigation signals. The built-in Glideslope receiver will automatically tune the corresponding glideslope paired frequencies (328 MHz to 335 MHz) when the localizer is tuned. The GNC 255 is available in 10 and 16 watt com transmitter versions. The GNC 255A is available with a 10 watt com transmitter. The GNC 255B is available with a 16 watt com transmitter.

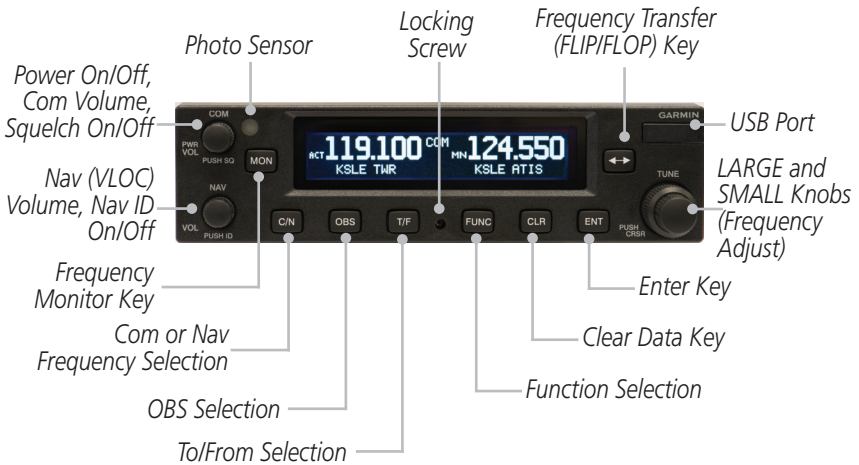

Figure 1-1 GNC 255 Front Panel Description

1.2 Pilot Controls

The GNC 255 controls have been designed to simplify operation of the system and minimize workload and the time required to access sophisticated functionality. Controls are comprised of dual concentric knobs for frequency tuning, Com volume/squelch knob, Nav volume/ID knob, and bezel keys.

1.2.1 Power/Com Volume/Squelch Knob



The **Power/Com Volume/Squelch** knob located in the top left corner of the bezel controls audio volume for the Com radio. Rotating the knob clockwise past the detent turns power on and counter-clockwise turns power off. When the Com radio is active, press the **Power/Com Volume/Squelch** knob to toggle automatic squelch control On/Off for the Com radio.

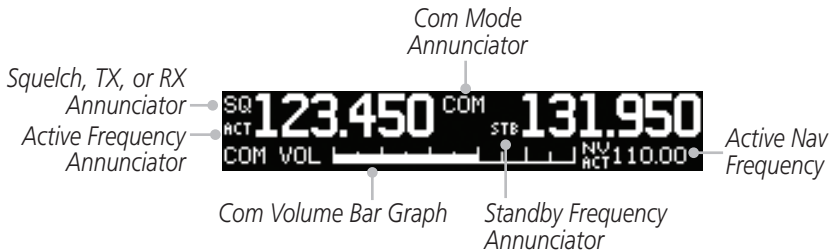

Figure 1-2 Com Volume and Squelch Display Description

The Com radio features an automatic squelch to reject many localized noise sources. You may override the squelch function by pressing the **Power/Com Volume/Squelch** knob. This facilitates listening to a distant station or setting the desired volume level.

To override the automatic squelch, press the **Power/Com Volume/Squelch** knob momentarily. Press the **Power/Com Volume/Squelch** knob again to return to automatic squelch operation. A “SQ” indication appears to the left of the active Com frequency window in the upper left corner of the display when automatic squelch is overridden.

1.2.2 Nav Volume/ID Knob



The **Nav Volume/ID** knob located in the bottom left corner of the bezel controls audio volume for the Nav radio. Press the **Nav Volume/ID** knob and the Morse code tones will be heard. When Morse code tone is active, “ID” will appear to the left of the Nav active frequency.

1.2.3 Tuning LARGE/SMALL Concentric (Cursor) Knobs

The **LARGE right** and **SMALL right** knobs are used for tuning frequencies and data entry.



1.2.4 FLIP/FLOP Key



Press and release the **FLIP/FLOP** key to switch between the active (left-most) and standby (right-most) frequency. Switching between Com frequencies is disabled while you are transmitting.

1.2.5 C/N (Com/Nav) Key



Press the **C/N** key to select the Com or Nav (VLOC) radio mode.

1.2.6 OBS Key



Press the **OBS** key to see the current OBS setting and graphic CDI. The OBS page will be disabled if the unit is installed with an external converter.

1.2.7 T/F (To/From) Key



Press the **T/F** key to toggle between the bearing TO or radial FROM the active VOR. The T/F page also shows Distance/Speed/Time information. The **T/F** key does not operate for Localizer frequencies.

1.2.8 CLR (Clear) Key



Pressing the **CLR** key erases information, cancels entries, and resets timers.

1.2.9 ENT (Enter) Key



Press the **ENT** key to save selected values, to confirm a prompt, or to save the Standby frequency.

1.2.10 FUNC (Function) Key

 **FUNC**

The **FUNC** (Function) key accesses function categories for the following: the Com Radio, Nav Radio, ICS Configuration, System Configuration, and Timer. Pressing the **FUNC** key once displays the Function mode. Pressing the **FUNC** key a second time exits the Function mode.

1.2.11 MON (Monitor) Key

 **MON**

The **MON** (Monitor) key will engage the monitor function where the Standby frequency may be monitored while still listening to the Active frequency.

1.3 USB Port

The USB port is used to update the frequency database in the GNC 255.



NOTE: *Garmin recommends the use of a USB 2.0 compatible USB flash drive for updating the database.*

2 BASIC OPERATION

2.1 Power On



Turn the GNC 255 on by either turning the **Power/Com Volume/Squelch** knob clockwise to turn the power on or, if installed, turning on the master switch that powers the radios.

2.2 Com Radio

2.2.1 Selecting a Com Frequency

New frequencies are first selected as a Standby frequency and then toggled to the Active side with the **FLIP/FLOP** key. While viewing the Standby frequency display, use the **LARGE** and **SMALL** knobs on the right side of the GNC 255 to select the desired frequency.



1. Press **C/N**, if necessary, to reach the Com radio function. The COM annunciator on the top line of the display will show.



2. Turn the **LARGE** knob to change the values in one MHz increments. The MHz selection range is between 118 and 136 in one MHz steps.

3. Turn the **SMALL** knob to change the values in 25 kHz or 8.33 kHz increments. The kHz selection range is between 000 and 975 kHz in 25 kHz steps or 000 and 990 kHz in 8.33 kHz steps.

4. Turn the **LARGE** and **SMALL** knobs clockwise to increase and counterclockwise to decrease the frequency values. Standby frequency selection is not inhibited during transmit.

5. When connected to a position source, nearby station identifiers will be shown for the selected frequency. Frequencies with multiple types will have an asterisk next to the identifier.



Asterisk Indicates Multiple Types Exist For The Selected Frequency

Identifier and Type Shown For The Selected Frequency

Figure 2-1 Com Frequency Selection



6. Press and release the **FLIP/FLOP** key to toggle the Standby frequency to the Active frequency.

2.2.2 Monitoring the Standby Com Channel

The Frequency Monitoring function allows you to monitor the Standby frequency for activity, while listening to the Active frequency.



Press the **MON** key in the Com function to listen to the standby frequency. A small “MN” will replace the “STB” to the left of the Standby frequency.



Figure 2-2 Com Frequency Monitor Annunciation

When the Active frequency receives a signal, the unit will switch automatically to the Active frequency. The Active frequency quality is not affected. The Frequency Monitor function is turned off by pressing the **MON** key again. Monitoring is not canceled by switching to Nav mode.

2.2.3 Saving a Com Channel

The current Standby frequency may be saved into the Com User Frequency database from the Com display or the Com User Function. The Com User Frequency database can hold up to 15 frequencies.



NOTE: When switching from 8.33 kHz to 25 kHz mode, any 8.33 kHz-specific user frequencies will be deleted from the user frequency list. This only affects the user frequencies within the 8.33 kHz spectrum.



1. Press **ENT**. The Standby frequency is selected and the Waypoint name field will be active.
2. Turn the **SMALL** knob to select characters.
3. Turn the **LARGE** knob to move the cursor.



Press the **ENT** Key to Save the Displayed Value

Press the **CLR** Key To Revert to the Previous Value

Turn **LARGE** Knob To Move Cursor

Figure 2-3 Com User Frequency Name Selection



4. After selecting the desired characters, press **ENT**.



5. Turn the **LARGE** knob to select the waypoint Type.
6. Turn the **SMALL** knob to select the Type from the list.



Figure 2-4 Com User Frequency Type Selection

| Frequency Type Symbol | Description |
|-----------------------|--|
| TWR | Tower |
| GND | Ground |
| ATIS | Automatic Terminal Information Service |
| AWS | Automated Weather Observing System |
| ATF | Aerodrome Traffic Frequency |
| ARR | Arrival |
| APPR | Approach |
| DEP | Departure |
| CLR | Clearance |
| CTAF | Common Traffic Advisory Frequency |
| FSS | Flight Service Station |
| RFS | Remote Flight Service Station |
| MF | Mandatory Frequency |
| UNI | Unicom |
| Blank | None |

Table 2-1 - Com Frequency Type List



7. After making a selection, press **ENT**.

2.2.4 Com Database Look-Up



1. Press the **CURSOR** knob from the Com display to activate the database look-up function.



Figure 2-5 Database Identifier Active for Selection



2. Turn the **SMALL** knob to select characters and turn the **LARGE** knob to move the cursor.



Figure 2-6 Database Identifier Selection



3. After selecting the desired characters, press **ENT**. Turn the **SMALL** knob to scroll through the list of waypoint types. Waypoint Types with a "+" sign will have more frequencies for the same type. After selection, the selected waypoint and type will be remembered for 30 minutes.



Figure 2-7 Database Waypoint Type Selection



4. Press **ENT** to copy the frequency into the Standby frequency location. Press and release the **FLIP/FLOP** key to swap the Active and Standby frequencies.

2.2.5 Frequency Database Reverse Look-Up

The identifier and frequency type will be shown for Com and Nav frequencies that are in the database when the unit is receiving a valid position input. Waypoint Types with a "+" sign will have more frequencies for the same type.



Figure 2-8 Frequency Database Reverse Look-Up

2.2.6 Emergency Channel



1. Press and hold the **FLIP/FLOP** key or the Com Remote Transfer (COM RMT XFR) key for approximately two seconds.



Figure 2-9 Emergency Channel

2. The Emergency Channel will be inserted into the Active Frequency position and the previous Active Frequency will become the Standby Frequency.



NOTE: Pressing and holding the Com Remote Transfer (COM RMT XFR) key for approximately two seconds, on units so configured, will lock the COM board, preventing further changes in Com frequency until the Com board is unlocked, by pressing the Com Remote Transfer key again for two seconds. The following message will notify the pilot that the Com board has been locked: "COM LOCKED TO 121.5 MHZ. HOLD REMOTE COM TRANSFER KEY TO EXIT."



NOTE: Under some circumstances if the Com system loses communication with the main system, the radio will automatically tune to 121.50 MHz for transmit and receive regardless of the displayed frequency.

2.2.7 Stuck Mic

The GNC 255 helps protect you from a situation where the microphone may get stuck in the ON or Transmit position. If the microphone is keyed for longer than 35 seconds, the GNC 255 will return to the receive mode on the selected frequency.

A "Stuck Mic" message will display until the transmit key is released. Alerts will display until the error clears or the user acknowledges it.

2.2.8 Remote Frequency Selection Control

On units configured for remote Com frequency Recall, pressing the remote recall switch will load the next preset Com frequency into the unit's Standby frequency box. The remote recall switch can be pressed multiple times to scroll the entire preset frequency list through the Standby frequency box (the list will "wrap" from the bottom of the list back up to the top, skipping any empty preset positions).

The standby frequency isn't activated until a Com **FLIP/FLOP** switch (either bezel-mounted or remote (COM RMT XFR) is pressed. Remote Frequency Selection only functions on units configured for a remote Com Frequency recall switch.

2.3 Nav Radio

2.3.1 Selecting a Nav Frequency

The selection of Nav frequencies is the same as for the Com frequencies.



1. Press the **C/N** key to reach the Nav radio function. The NAV annunciator on the top line of the display will show.



2. Turn the **LARGE** knob to change the values in one MHz increments. The MHz selection range is between 108 and 117 MHz in one MHz steps.

3. Turn the **SMALL** knob to change the values in 50 kHz increments.



Identifier and Type Shown For The Selected Frequency

Figure 2-10 Nav Frequency Selection



CAUTION: *The Identifier is determined from the database and is not the decoded Nav Identifier.*



4. Press and release the **FLIP/FLOP** key to toggle the Standby frequency to the Active frequency.



NOTE: *Both Nav and Com frequencies cannot be displayed at the same time.*

2.3.2 Saving a Nav Channel

The current Standby frequency may be saved into the Nav User Frequency database from the Nav or the Nav User Function. The Nav User Frequency database can hold up to 15 frequencies.



1. Press **ENT**. The Waypoint name field will be active.

2. Turn the **SMALL** knob to select characters.

3. Turn the **LARGE** knob to move the cursor.



Figure 2-11 Nav User Frequency Name Selection



4. After selecting the desired characters, press **ENT**.



5. Turn the **LARGE** knob to select the waypoint Type.
6. Turn the **SMALL** knob to select characters.
7. Turn the **LARGE** knob to move the cursor.



Figure 2-12 Nav User Frequency Type Selection



8. After selecting the desired characters, press **ENT**.

| Frequency Type Symbol | Description |
|-----------------------|--|
| VOR | Very High Frequency Omni-Directional Range |
| DME | Distance Measuring Equipment |
| LOC | Localizer |
| ILS | Instrument Landing System |
| 01-36 | Runway Heading |
| Blank | None |

Table 2-2 - Nav Frequency Type List

2.3.3 Listening to the Nav Audio Channel

Nav ident is enabled by pressing the **Nav Volume** knob when the Nav display is active. When Nav ident is enabled, the ID annunciation will appear to the left of the active Nav frequency.



Figure 2-13 Listening to the ID for a Nav Frequency

Nav audio volume is adjusted using the **Nav Volume** knob. Turn the **Nav Volume** knob clockwise to increase volume, or counterclockwise to decrease volume.

2.4 OBS Mode

If your system is configured with an external CDI/HSI, the OBS radial of your remote display will be decoded and displayed on the screen of the GNC 255.



NOTE: *The Identifier is the decoded Nav Identifier from the Morse code broadcast by the station.*



1. Press the **OBS** key to see the current OBS setting and graphic CDI.



2. Use the **LARGE** and **SMALL** knobs to change the displayed OBS values.

The GNC 255 graphic CDI is shown as a graph of five dots right or left of the triangle icon. Each dot indicates two degrees deflection with ten degrees full deflection to each side. Fly towards the bar to be on-course.

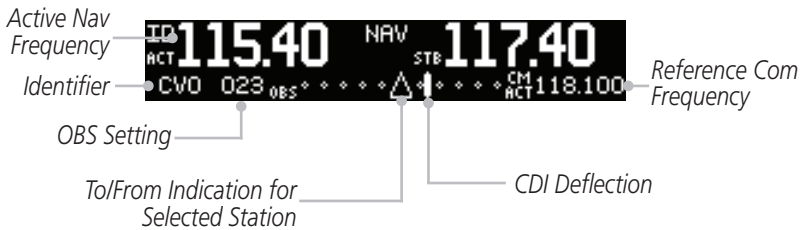

Figure 2-14 CDI Display

2.5 Distance/Speed/Time (DST) Display

When the GNC 255 has received data from an external device, such as a GPS receiver or DME sensor through the serial port, DST data will be available. If you are not connected to an external sensor, you will not see this display.



If DST data is not shown, pressing the **T/F** key will show DST data in the lower part of the display.

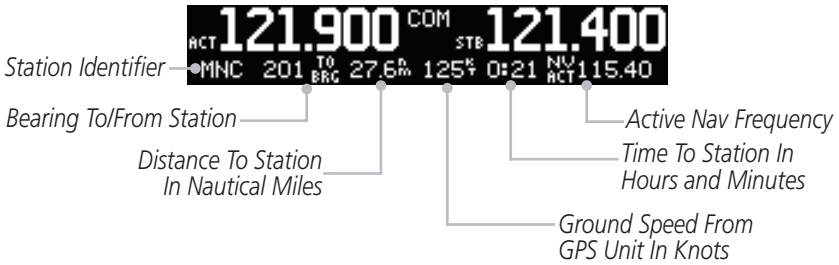

Figure 2-15 DST Data Display



NOTE: If both GPS and DME data sources are connected to the GNC and dashes are displayed when distance/speed/time data is expected to be displayed, press the T/F key to prompt the GNC to display DST data.

This page intentionally left blank

3 FUNCTIONS

The Functions section allows provides information about Com Frequencies, Nav Frequencies, Internal Communications System (ICS) Configuration, System Configuration (SYS), and Timers (TMR).

3.1 Functions Description

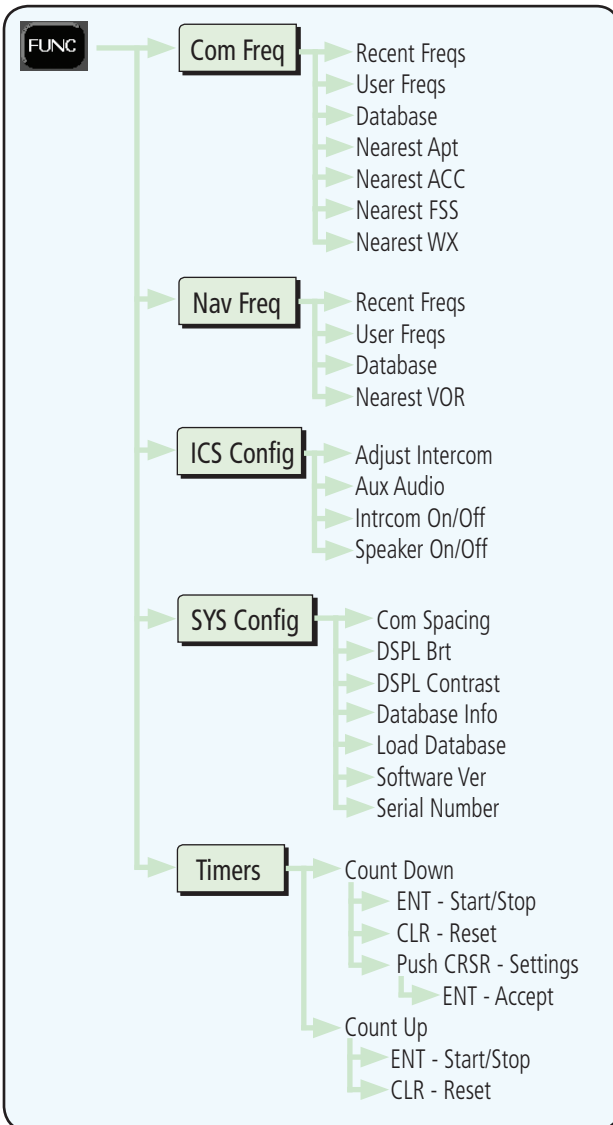

Figure 3-1 Functions Diagram



1. Press the **FUNC** key to access the Functions.



2. Turn the **LARGE** knob to select the COM, NAV, ICS, or SYS functions.



4. Press the **ENT** key to access the function.



5. Press the **FUNC** key again to exit Functions.

3.2 Com Frequencies

The Com Frequencies category in the Functions section contains recently used frequencies (Recent), user-defined frequencies (User), and a database of all frequencies provided in the standard default memory (Database).

3.2.1 Recent Com Frequencies

The last 20 Com frequencies used are kept in the list of Recent Com Frequencies and can be accessed in this function.



NOTE: When switching from 8.33 kHz to 25 kHz mode, any 8.33 kHz-specific user frequencies will be deleted from the user frequency list. This only affects the user frequencies within the 8.33 kHz spectrum.



1. Press **FUNC** to access the Functions. Turn the **LARGE** knob to select the Com Function. Turn the **SMALL** knob to view the Recent frequency function. Then, press **ENT**.

2. Turn the **SMALL** knob to select an Entry (1-20).



Press <-> To Make the Selected Frequency The Active Frequency (pointing to the left arrow key)

Press ENT to Make the Selected Frequency the Standby (pointing to the ENT key)

Figure 3-2 Recent Com Frequencies



3. Press and release the **FLIP/FLOP** key to transfer the displayed channel to the Active frequency position. Press the **ENT** key to transfer the displayed channel to the Standby frequency position.



3.2.2 Com User Frequencies

Fifteen Com User Frequencies can be saved with an assigned waypoint (WPT) identifier and Type.



NOTE: When switching from 8.33 kHz to 25 kHz mode, any 8.33 kHz-specific user frequencies will be deleted from the user frequency list. This only affects the user frequencies within the 8.33 kHz spectrum.

3.2.2.1 Viewing the Com User Frequency



1. Press **FUNC** to access the Functions. Turn the **LARGE** knob to select the Com Frequency Function.



Select Wpt Name

Select Wpt Type

Figure 3-3 Viewing User Com Frequencies



2. Turn the **SMALL** knob to view the Com User frequency function. Then, press **ENT**. Turn the **SMALL** knob to view the User Frequencies.



3. Press and release the **FLIP/FLOP** key to set the displayed frequency as the Active frequency.



4. Press the **ENT** key to set the displayed frequency as the Standby frequency.

3.2.2.2 Deleting the Com User Frequency



1. Press the **CLR** key to delete this User frequency.

Press ENT Key To Delete
Selected Freq

Active Frequency



Position In List.
Turn SMALL Knob
To Select Entry.

Press ENT To Confirm
Deleting The Selected Freq

Selected Frequency

Figure 3-4 Deleting User Com Frequencies



- Press the **ENT** key to confirm deletion of the displayed frequency.

3.2.2.3 Editing a Com User Frequency



- Press **FUNC**. Turn the **LARGE** knob to reach the Com functions and then turn the **SMALL** knob to select the Com User Frequencies. Press **ENT**.

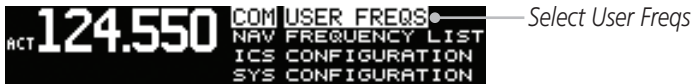

Figure 3-5 Com User Frequency Function



- Press the **CRSR** (**SMALL** knob) to start editing the Com User frequency. Turn the **SMALL** knob to select the MHz values and turn the **LARGE** knob to move the cursor and then the **SMALL** knob to select kHz values.



Figure 3-6 Com User Frequency Value Selection



- Turn the **LARGE** knob to select the Wpt Name. Turn the **SMALL** knob to select characters and turn the **LARGE** knob to move the cursor.



Figure 3-7 Com User Frequency Name Selection



- After selecting the desired characters, press **ENT**.
- Turn the **LARGE** knob to select the Waypoint Type field.
- Turn the **SMALL** knob to select the Waypoint Type.



Figure 3-8 Com User Frequency Type Selection



- After selecting the Waypoint Type, press **ENT** to accept changes to the User Frequency.

3.2.3 Com Database Frequencies

The GNC 255 contains a large database of Com frequencies that may be recalled by identifier.



Figure 3-9 Com Database Frequencies



1. Press **FUNC** to access the Functions. With the Com Frequency Function highlighted, turn the **SMALL** knob to view the Com Database function. Then, press **ENT**.



2. Turn the **SMALL** knob to select the desired character.
3. Turn the **LARGE** knob to move the cursor to highlight a character.



4. Repeat steps 2 and 3 to complete the desired identifier and then press the **ENT** key.



5. If available, the Frequency Type will be highlighted. Turn the **SMALL** knob to select the desired frequency.

Press ENT Key To Set Selected Freq As Standby

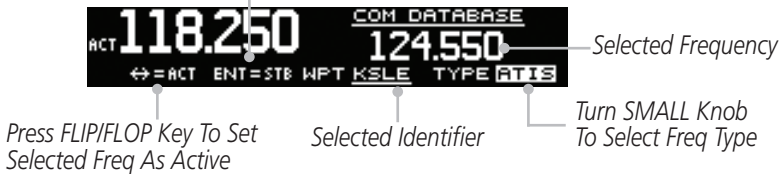

Figure 3-10 Selected Com Database Frequency



6. Press and release the **FLIP/FLOP** key to set the selected frequency as the Active frequency.



7. Press the **ENT** key to set the selected frequency as the Standby frequency.

3.2.4 Com Nearest Airports (APT)

The GNC 255 will report the 25 nearest Airports (APT), when interfaced with an appropriate GPS receiver.



Figure 3-11 Com Nearest APT Frequencies



1. Press **FUNC** to access the Functions. With the Com Frequency Function highlighted, turn the **SMALL** knob to view the Com Nearest APT function. Then, press **ENT**.



2. Turn the **SMALL** knob to display the available airports. Press the **ENT** key to select the displayed airport. The frequency type will be highlighted. Turn the **SMALL** knob to select the desired frequency type.



3. Then, press the **ENT** key to set the displayed airport frequency as the Standby or press and release the **FLIP/FLOP** key to set it as the Active frequency. Or, press the **CLR** key to return to the Functions display.

3.2.5 Com Nearest Area Control Center (ACC) Frequencies

The GNC 255, when interfaced with an appropriate GPS receiver, will report the 25 nearest Area Control Center (ACC) frequencies. ACCs are also known as Air Route Traffic Control Centers (ARTCC).



Figure 3-12 Com Nearest ACC Frequencies



1. Press **FUNC** to access the Functions. With the Com Frequency Function highlighted, turn the **SMALL** knob to view the Com Nearest ACC function. Then, press **ENT**.



2. Turn the **SMALL** knob to display the available ACCs.



3. Press the **ENT** key to insert the highlighted frequency as the Standby frequency. Or, press the **CLR** key to return to the Functions display.



4. Press and release the **FLIP/FLOP** key to set the selected frequency as the Active frequency.

3.2.6 Com Nearest Flight Service Station (FSS) Frequencies

The GNC 255, when interfaced with an appropriate GPS receiver, will report the 25 nearest Flight Service Station (FSS) frequencies.



Figure 3-13 Com Nearest FSS Frequencies



1. Press **FUNC** to access the Functions. With the Com Frequency Function highlighted, turn the **SMALL** knob to view the Com Nearest FSS function. Then, press **ENT**.



2. Turn the **SMALL** knob to display the available FSS frequencies.



3. Press the **ENT** key to insert the highlighted frequency as the Standby frequency. Or, press the **CLR** key to return to the Functions display.



4. Press and release the **FLIP/FLOP** key to set the selected frequency as the Active frequency.

3.2.7 Com Nearest Weather (WX) Frequencies

The GNC 255, when interfaced with an appropriate GPS receiver, will report the 25 nearest Weather (WX) frequencies.



Figure 3-14 Com Nearest Weather Frequencies



1. Press **FUNC** to access the Functions. With the Com Frequency Function highlighted, turn the **SMALL** knob to view the Com Nearest Weather function. Then, press **ENT**.



2. Turn the **SMALL** knob to display the available Weather frequencies.



3. Press the **ENT** key to insert the highlighted frequency as the Standby frequency. Or, press the **CLR** key to return to the Functions display.



4. Press and release the **FLIP/FLOP** key to set the selected frequency as the Active frequency.

3.3 Nav Frequencies

The Nav Frequencies category in the Functions section contains remotely acquired frequencies (Remote), recently used frequencies (Recent), user-defined frequencies (User), and a database of all frequencies provided in the standard default memory (Database).

3.3.1 Recent Nav Frequencies

The last 20 Nav frequencies used are kept in the list of Recent Nav Frequencies and can be accessed in this function.

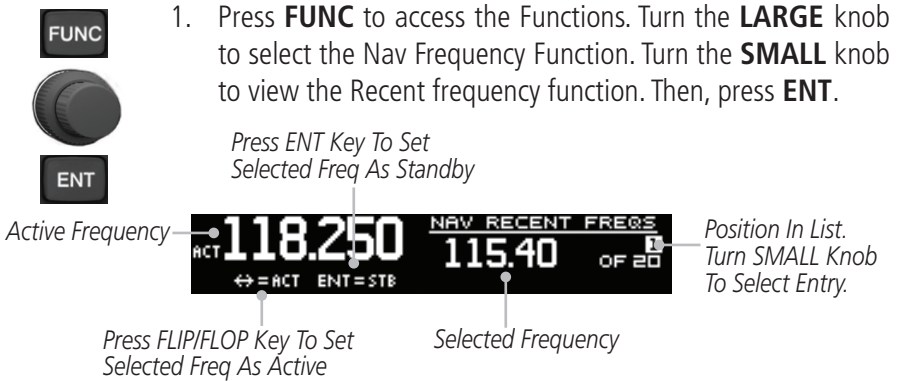



1. Press **FUNC** to access the Functions. Turn the **LARGE** knob to select the Nav Frequency Function. Turn the **SMALL** knob to view the Recent frequency function. Then, press **ENT**.

Press ENT Key To Set Selected Freq As Standby

Press FLIP/FLOP Key To Set Selected Freq As Active

Position In List. Turn SMALL Knob To Select Entry.

Figure 3-15 Recent Nav Frequencies

- 
- 
- 
2. Turn the **SMALL** knob to select an Entry (1-20). If a GPS position is available, the area below frequency will show the nearest facility name/type, if available.
 3. Press and release the **FLIP/FLOP** key to transfer the displayed channel to the Active frequency position or press the **ENT** key to transfer the displayed channel to the Standby frequency position.

3.3.2 Nav User Frequencies

Up to 15 Nav User Frequencies can be saved with an assigned waypoint (WPT) identifier and Type.

3.3.2.1 Viewing the Nav User Frequency

1. Press **FUNC** to access the Functions. Turn the **LARGE** knob to select the Nav Frequency List Function. Turn the **SMALL** knob to view the Nav User Frequency function. Then, press **ENT**.

Press ENT Key To Set Selected Freq As Standby

Press FLIP/FLOP Key To Set Selected Freq As Active

Position In List. Turn SMALL Knob To Select Entry.

Figure 3-16 Viewing User Nav Frequencies

-
2. Turn the **SMALL** knob to view the Nav User Frequencies.
 3. Press and release the **FLIP/FLOP** key to set the displayed frequency as the Active frequency.
 4. Press the **ENT** key to set the displayed frequency as the Standby frequency.

3.3.2.2 Deleting the Nav User Frequency

1. While viewing a Nav User frequency, press the **CLR** key to delete the displayed User frequency.

Press ENT Key To Confirm Deleting The Frequency

Press ENT To Delete The Selected Freq

Position In List. Turn SMALL Knob To Select Entry.

Figure 3-17 Deleting User Nav Frequencies

-
2. Press the **ENT** key to delete the displayed frequency.

3.3.2.3 Editing a Nav User Frequency

FUNC



ENT

1. Press **FUNC**. Turn the **LARGE** knob to reach the Nav functions and then turn the **SMALL** knob to select the Nav User Frequencies. Press **ENT**.



Figure 3-18 Nav User Frequency Function

2. Turn the **SMALL** knob to select the desired Nav User frequency and then press **ENT**. Press the Cursor knob to enable editing. The frequency MHz value will be selected. Turn the **SMALL** knob to select the MHz frequency value. Turn the **LARGE** knob to move the cursor and then turn the **SMALL** knob to select the kHz frequency value.



3. Turn the **LARGE** knob to select the WPT name. Turn the **SMALL** knob to select characters and turn the **LARGE** knob to move the cursor.



Figure 3-19 Nav User Frequency Name Selection

ENT

4. After selecting the desired characters, press **ENT**.

5. Turn the **LARGE** knob to select the waypoint Type.

6. Turn the **SMALL** knob to select characters and Turn the **LARGE** knob to move the cursor.



Figure 3-20 Nav User Frequency Type Selection

ENT

7. After selecting the desired characters, press **ENT**.

3.3.3 Nav Database Frequencies

The GNC 255 contains a large database of Nav frequencies that may be recalled by identifier.



1. Press **FUNC** to access the Functions. With the Nav Frequency Function highlighted, turn the **SMALL** knob to view the Nav Database function. Then, press **ENT**.
2. Turn the **LARGE** knob to move the cursor to highlight a character.
3. Turn the **SMALL** knob to select the desired character.



Turn SMALL Knob
To Select Character
Turn LARGE Knob
To Move Cursor

Press the ENT Key to Save
the Displayed Value

Press the CLR Key To Return
to the Previous Menu

Figure 3-21 Nav Database Frequencies



4. Repeat steps 2 and 3 to complete the desired identifier and then press the **ENT** key.
5. If available, the Frequency Type will be highlighted. Turn the **SMALL** knob to select the desired frequency.

Press ENT Key To Set
Selected Freq As Standby



Selected Frequency

Press FLIP/FLOP Key To Set
Selected Freq As Active

Selected Identifier

Wpt Type

Figure 3-22 Selected Nav Database Frequency



6. Press and release the **FLIP/FLOP** key to set the selected frequency as the Active frequency.
7. Press the **ENT** key to set the selected frequency as the Standby frequency.

Duplicate Identifiers

1. When duplicate identifiers are found, press **ENT**.



Press the ENT Key to Save the Displayed Value

Press the CLR Key To Return to the Previous Menu

Figure 3-23 Selected Nav Database Frequency

2. Turn the **SMALL** knob to select the desired identifier and then press **ENT** and continue as described above.



Figure 3-24 Selected Ident from Nav Database

3. Set the selected identifier as the standby or active frequency.

Press ENT Key To Set Selected Freq As Standby



Press FLIP/FLOP Key To Set Selected Freq As Active

Selected Identifier

Wpt Type

Figure 3-25 Set Selected Frequency as Active or Standby

3.3.4 Nav Nearest VOR

The GNC 255, when interfaced with an appropriate GPS receiver, will report the 25 nearest VORs.



Figure 3-26 Nav Nearest VOR Frequencies



1. Press **FUNC** to access the Functions. With the Nav Frequency Function highlighted, turn the **SMALL** knob to view the Nav Nearest VOR function. Then, press **ENT**.



ENT

CLR

- Turn the **SMALL** knob to display the available VORs.
- Press the **ENT** key to accept the displayed VOR and set it as the Standby frequency. Or, press the **CLR** key to return to the Functions display.

3.4 ICS Configuration

The Internal Communications System (ICS) Configuration allows you to adjust the intercom, set the Nav/Aux volume, turn the Intercom On/Off, and turn the intercom speaker On/Off.

3.4.1 Adjust Intercom

The Adjust Intercom function allows you to set values for the Intercom squelch and volume. The Intercom On/Off function must be set to On to make the Adjust Intercom function available.

FUNC



ENT

- Press **FUNC** to access the Functions. Turn the **LARGE** knob to select the ICS Function. Turn the **SMALL** knob to view the Adjust Intercom function. Then, press the **ENT** key.



Figure 3-27 Select the Adjust Intercom Function

- Turn the **SMALL** knob to set the ICS Squelch value. Then, press the **ENT** key.

Turn Small Knob To Adjust Intercom Squelch



ENT



Turn LARGE And Then SMALL Knob To Adjust Intercom Volume

Press the ENT Key to Save the Displayed Value

Press the CLR Key To Revert to the Previous Value

Figure 3-28 Adjust the Intercom Values



ENT

- Turn the **LARGE** knob to select the ICS Squelch or Volume. Turn the **SMALL** knob to set the value. Then, press the **ENT** key to save the selected values.

3.4.2 Aux Audio

The Aux function allows you to turn Aux Audio On/Off and set the volume value.



1. Press **FUNC** to access the Functions. Turn the **LARGE** knob to select the ICS Function. Turn the **SMALL** knob to view the Aux Volume function. Then, press the **ENT** key.



Figure 3-29 Select the Aux Audio Function



2. Turn the **SMALL** knob to turn the Aux Audio On or Off.
3. Turn the **LARGE** knob to select the Aux Volume. Turn the **SMALL** knob to set the value. Then, press the **ENT** key.

Turn Small Knob To Turn Aux On/Off



Turn LARGE And Then SMALL Knob To Adjust Aux Volume

Press the ENT Key to Save the Displayed Value

Press the CLR Key To Revert to the Previous Value

Figure 3-30 Adjust Aux Audio



4. Press the **CLR** key to revert to the previous Volume value and then repeat step 3 to select a new value.

3.4.3 Intercom On/Off

The Intercom On/Off function toggles intercom on and off. The intercom can also be toggled on/off with a remote switch, if installed. The Intercom On/Off function must be set to On to make the Adjust Intercom function available.

FUNC



ENT

1. Press **FUNC** to access the Functions. Turn the **LARGE** knob to select the ICS Function. Turn the **SMALL** knob to view the Intercom On/Off function. Then, press the **ENT** key.

Turn SMALL Knob To Select On or Off



Press ENT to Accept the Selected Value

Press CLR to Return to the Default Value

Figure 3-31 Turn the Intercom On/Off



ENT

2. Turn the **SMALL** knob to set the Intercom On or Off. Then, press the **ENT** key to save the selected value.

3.4.4 Speaker On/Off

The Speaker On/Off function toggles speaker output on and off.

FUNC



ENT

1. Press **FUNC** to access the Functions. Turn the **LARGE** knob to select the ICS Function. Turn the **SMALL** knob to select the Speaker On/Off function. Then, press **ENT**.

Turn SMALL Knob To Select On or Off



Press ENT to Accept the Selected Value

Press CLR to Return to the Default Value

Figure 3-32 Turn the Speaker On/Off



ENT

2. Turn the **SMALL** knob to set the speaker output On or Off. Then, press the **ENT** key to save the selected value.

3.5 System Configuration

The System Configuration function will show the Software Version, Database Info, and Serial Number as well as, allowing you to set values for the Com spacing, Display Brightness, and Display Contrast, and use the Load Database feature to update databases.

3.5.1 Com Spacing

Com spacing may be selected between 8.33 kHz and 25 kHz to allow for regional requirements.



NOTE: When switching from 8.33 kHz to 25 kHz mode, any 8.33 kHz-specific user frequencies will be deleted from the user frequency list. This only affects the user frequencies within the 8.33 kHz spectrum.



1. Press **FUNC** to access the Functions. Turn the **LARGE** knob to select the SYS Function. Turn the **SMALL** knob to view the Com spacing function. Then, press the **ENT** key.

*Turn the SMALL Knob to
Select the Channel Spacing*



*Press ENT to Accept
the Selected Value*

*Press CLR to Return to
the Previous Value*

Figure 3-33 Com Spacing Display



2. Turn the **SMALL** knob to set the Com spacing and then press the **ENT** key.

3.5.2 Display Brightness

As it arrives from the factory, the GNC 255 automatically adjusts its display brightness for the current lighting conditions. A small sensor on the display is used for this function. A manual adjustment is available for controlling the brightness level of the display as an offset from the “normal” or zero position.

The limits of the adjustment range are: -10 (Low Display Intensity) and 100 (High Display Intensity). A value above zero means brighter than normal and a value below zero means darker than normal. The range can be adjusted by using the **SMALL** knob to adjust the value.

The GNC 255 will either control dimming based on the photocell or the lighting bus. This is set in configuration mode during installation and is not selectable by the pilot.

1. Press **FUNC** to access the Functions. Turn the **LARGE** knob to select the SYS Function. Turn the **SMALL** knob to view the Display Brightness function. Then, press the **ENT** key.

Press ENT to Accept the Selected Value *Press CLR to Return to the Previous Value* *Turn the SMALL Knob to Select the Offset Value*

Figure 3-34 Set Display Brightness

2. Turn the **SMALL** knob to set the value. Then, press the **ENT** key.

3.5.3 Display Contrast

The Display Contrast has a range from -50 (Low Display Contrast) and 50 (High Display Contrast) with 0 as the default. The range can be adjusted by using the **SMALL** knob to adjust the value.

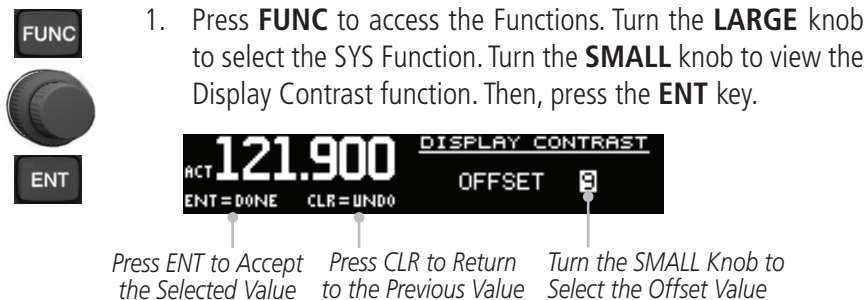

1. Press **FUNC** to access the Functions. Turn the **LARGE** knob to select the SYS Function. Turn the **SMALL** knob to view the Display Contrast function. Then, press the **ENT** key.

Press ENT to Accept the Selected Value Press CLR to Return to the Previous Value Turn the SMALL Knob to Select the Offset Value

Figure 3-35 Set Display Contrast

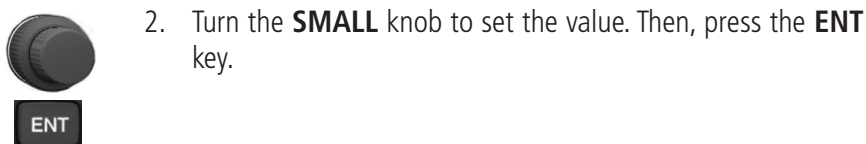

2. Turn the **SMALL** knob to set the value. Then, press the **ENT** key.

3.5.4 Database Info

The Database information for the GNC 255 unit is displayed. This information is useful when contacting Customer Support.

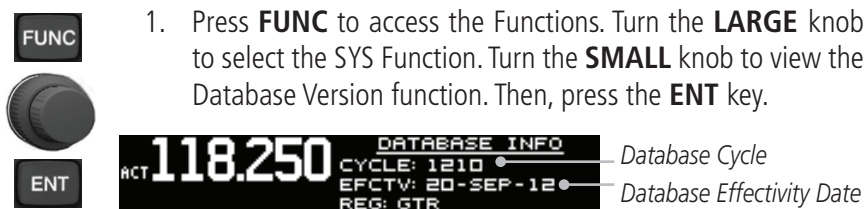

1. Press **FUNC** to access the Functions. Turn the **LARGE** knob to select the SYS Function. Turn the **SMALL** knob to view the Database Version function. Then, press the **ENT** key.

Database Cycle
Database Effectivity Date

Figure 3-36 Database Info Display



2. Press the **FUNC** key to return to the main display.

3.5.5 Load Database

The GNC 255 has a USB connector to allow for easily updating the system databases.



NOTE: *Garmin recommends the use of a USB 2.0 compatible USB flash drive for updating the database.*

1. Insert the supplied cable into the USB port on the top right corner of the GNC 255.
2. Insert the USB memory device into the other end of the cable.

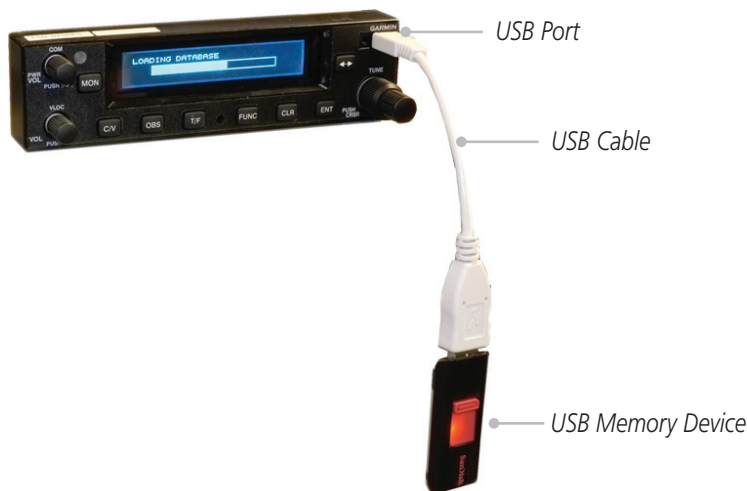

Figure 3-37 USB Update Progress



3. Press **FUNC** to access the Functions. Turn the **LARGE** knob to select the SYS Function. Turn the **SMALL** knob to view the Load Database function. Then, press the **ENT** key.



Figure 3-38 Database Update Display



4. Verify the database version on USB. Then, press the **ENT** key. Updating will begin automatically.



Figure 3-39 Verify Database Version

5. Wait until the updating process is complete and then remove the memory device and cable. The unit will reset automatically once the database is updated.
6. Verify the correct frequency database is loaded after power-up.

3.5.6 Software Version

The software versions of the GNC 255 unit are displayed. This information is useful when contacting Customer Support.

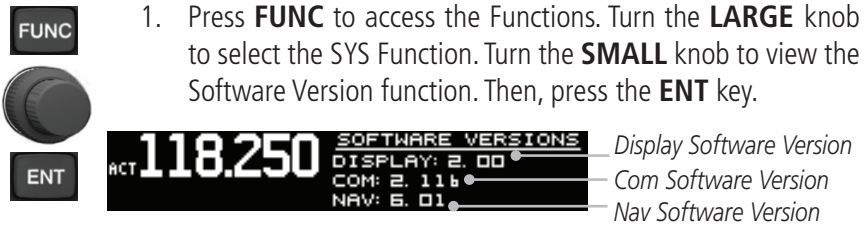

Figure 3-39 Software Versions Display

2. Press the **FUNC** key to return to the main menu.

3.5.7 Serial Number

The serial number of the GNC 255 unit is displayed. This information is useful when contacting Customer Support.

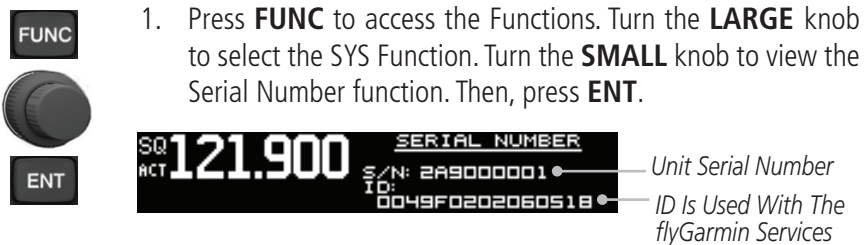

Figure 3-40 Serial Number Display

2. Press the **FUNC** key to return to the main menu.

3.6 Timers

The GNC 255 has both Count Up and Count Down timers, which may operate simultaneously and are shown in the lower right of the Com/Nav displays. The countdown timer always takes precedence if it is running.

3.6.1 Setting Up the Count Down Timer

FUNC



ENT



Select Count Down Timer

Figure 3-41 Select the Count Down Timer Function

ENT

CLR



- Press the **ENT** key to Start or Stop the timer. Press the **CLR** key to reset the timer to the starting value. Press the **CURSOR** knob to select a starting timer value.

The Default (Starting) Value



Push the **CURSOR** (SMALL Knob) to Edit the Starting Time Value

Press **ENT** to Start or Stop the Timer

Press **CLR** to Reset the Timer to the Default Value

Figure 3-42 Selecting the Count Down Timer



ENT

- Turn the **SMALL** knob to select the timer value and turn the **LARGE** knob to move the cursor. After completing the time setting, press the **ENT** key. Press **ENT** again to start the timer.

Turn **SMALL** Knob To Select Time Value



Press **ENT** to Accept the Selected Value

Press **CLR** to Return to the Default Value

Turn **LARGE** Knob To Move Cursor

Figure 3-43 Setting the Count Down Timer Value

3.6.2 Setting Up the Count Up Timer



1. Press **FUNC** to access the Functions. Turn the **LARGE** knob to select the Timer (TMR) function. Turn the **SMALL** knob to select the Count Up Timer function. Now, press the **ENT** key.



— Select Count Up Timer

Figure 3-44 Select the Count Up Timer Function



2. Press the **ENT** key to Start or Stop the timer. Press the **CLR** key to reset the timer to 0:00.

The Default (Starting) Value



Press ENT to Start or Stop the Timer

Press CLR to Reset the Timer to 0:00

Figure 3-45 Selecting the Count Up Timer

3.6.3 Viewing Timers in the Com Display

When a timer is active, the timer value will be shown in the lower right corner of the Com display. While both timers may be actively counting at the same time, the Count Down Timer will have precedence in being shown. If the Count Down Timer is paused, the Count Up Timer will then be shown until the Count Down Timer is restarted.



— Timer Value

Figure 3-46 Timer Value Shown in the Com Display



1. Pressing **CLR** and then **ENT** will reset the displayed Timer.



Figure 3-47 Stop or Clear the Timer in the Com Display



2. Pressing **ENT** twice will stop the displayed Timer.

When the Count Down Timer reaches 0:00, it will continue counting as a Count Up value. The Count Down Timer that is counting up will be highlighted. A Count Up Timer will continue counting separately.



Figure 3-48 Count Down Timer Value Now Counting Up

This page intentionally left blank

4 APPENDIX

4.1 Troubleshooting

If efforts to resolve the problem fail, contact your dealer or the factory for technical assistance. The Garmin customer service staff will gladly assist you.

Please have the following information ready:

- System configuration (products, antennas, mounting locations, etc.)
- Model No., part number, and serial number
- Software versions
- Description of the problem
- Efforts made to isolate/solve the problem

Garmin International, Inc.
Aviation Products Customer Service Department
1200 East 151st Street
Olathe, KS 66062-3426 USA

If you have any questions, the Garmin AT Product Support department may be reached Monday through Friday, 7:00 AM to 7:00 PM Central Time.

US: 913-397-8200

US Toll Free: 1-866-739-5687

Canada Toll Free: 1-866-429-9296

e-mail: support.gat@garmin.com.

<http://www.garmin.com>

<https://fly.garmin.com/fly-garmin>

| Problem | Possible Cause | Action |
|-------------------------------|--|---|
| GNC 255 does not power on | No power to the GNC 255 | Check power connections, breakers, and main avionics switch |
| | Faulty electrical wiring or connection | Contact your dealer to perform electrical system test |
| No Nav audio | Output disabled or set to a low level | Contact dealer |
| Nav audio in Com | Mixed with Com feature | Contact dealer |
| GNC 255 does not transmit | No power to Com | Check power connections |
| | Mic key connection | Check Mic key input connection |
| Intercom doesn't function | It can be enabled or disabled via a remote mounted switch or via the menu. | Check connections |
| | No voice activation, or if must talk too loud | Check ICS page, Intercom On/Off, Adjust Intercom |
| Can't change active frequency | Com Radio not communicating. The radio may also be in lockout mode. In this case the radio would be tuned to 121.50 and the active freq would not be able to be changed. | If in Lock Out mode, press the external Com FLIP/FLOP key for two seconds to return to normal operation or cycle the avionics power. If the condition persists, contact dealer. |
| OBS readout displays " --- " | Resolver failure | Contact dealer |
| | Calibration error | Recalibrate resolver |

| Problem | Possible Cause | Action |
|--|---|-----------------|
| Display shows "Incorrect Calibration Checksum" at start-up | Corrupted system calibration parameters | Contact factory |

Table 4-1 Troubleshooting

4.2 Updating the Frequency Database

The GNC 255 uses a standard USB memory device to load the frequency database into the GNC 255. The memory device is not provided by Garmin. The Frequency database is stored internally and the USB memory device is only used to transfer the database into the unit.

The Garmin databases can be updated by following the instructions on <https://fly.garmin.com/fly-garmin>.

The following equipment is required to perform the update:

- Windows-compatible PC computer (Windows 2000, XP, Vista, or Windows 7 recommended)
- USB 2.0 compatible USB flash drive
- External USB cable
- Updated database obtained from the Garmin web site



NOTE: *The data contained in the frequency database comes from government agencies. Garmin accurately processes and cross-validates the data, but cannot guarantee the accuracy and completeness of the data.*

4.2.1 Downloading the Frequency Database

The Frequency database is updated on a 28-day cycle. Frequency database updates are provided by Garmin and may be downloaded from the Garmin web site <https://fly.garmin.com/fly-garmin>.

4.2.2 Updating the GNC 255 Frequency Database

See Section 3.5.5 for details on updating the database.

4.3 Messages

When a Message has been issued by the unit, the Message will be shown on the display. After viewing the messages, touch the **ENT** key to acknowledge the message and return to the previously viewed page. An acknowledged message will not be redisplayed even if the condition persists. Messages provide an aid to troubleshooting system operation.



Figure 4-1 Message - Com PTT Key Stuck

| Message | Description | Action |
|--|--|---|
| COM RADIO - Com radio needs service. | The com radio is reporting that it needs service. The com radio may continue to function. | Cycle the power to the COM radio. Contact dealer for service. |
| COM RADIO - Com radio may be inoperative. | The com radio is not communicating properly with the system. | Press and hold the volume knob or the external com remote transfer (COM RMT XFR) switch, if installed – this will force the com radio to 121.5 MHz. Contact dealer for service. |
| COM RADIO - Com overtemp or undervoltage. Reducing transmitter power. | Com radio is in overtemp or undervoltage mode and transmitting power has been reduced to prevent damage to the com radio. Radio range will be reduced. | Decrease length of com transmissions, decrease cabin temperature and increase cabin airflow (especially near the GTN). Check aircraft voltage and reduce electrical load as necessary. Contact dealer for service if this message persists. |
| COM RADIO - Com locked to 121.5 MHz. Hold remote com transfer key to exit. | Com radio is locked to 121.5 MHz. | The external com remote transfer (COM RMT XFR) switch has been held and the com radio is tuned to 121.5. To exit this mode, hold the com remote transfer (COM RMT XFR) switch for two seconds. |

| Message | Description | Action |
|--|---|--|
| COOLING FAN - The cooling fan has failed. | The GTN cooling fan is powered, but it is not turning at the desired RPM. | Decrease cabin temperature and increase cabin airflow (especially near the GTN) to prevent damage to the unit. Contact dealer for service. |
| DISPLAY - Display board needs service. | The display board is indicating that it needs service. | Contact dealer for service. |
| GLIDESLOPE - Glideslope receiver needs service. | The glideslope board is indicating that it needs service. The glideslope board may continue to function. | Verify glideslope deviation indications with another source and crosscheck final approach fix crossing altitude. If another glideslope source is not available for verification, fly a GPS based approach. Contact dealer for service. |
| GLIDESLOPE - Glideslope receiver has failed. | The glideslope board is not communicating property with the system. | Fly an approach that does not use the glideslope receiver (VOR, LOC, GPS). Contact dealer for service. |
| POWER ALERT - Unit will shut down if power switch is not restored immediately. | Power has been removed from the unit. | Re-apply power to the unit. |
| REMOTE KEY STUCK - Com push-to-talk key is stuck. | The Push To Talk key/switch has been in pressed position for at least 30 seconds. This input will now be ignored and the com radio will no longer transmit. | Verify the Push To Talk key/switch is not stuck. Contact dealer for service if this message persists. |

| Message | Description | Action |
|---|--|---|
| <p>REMOTE KEY STUCK - Com remote transfer key is stuck.</p> | <p>The remote com transfer (COM RMT XFR) key/switch has been in pressed position for at least 30 seconds. This input will now be ignored. This input is not available in all installations.</p> | <p>Verify the COM RMT XFR key/switch is not stuck. Contact dealer for service if this message persists.</p> |
| <p>REMOTE KEY STUCK - Com remote frequency increment key is stuck.</p> | <p>The remote com frequency increment (COM CHAN UP) key/switch has been in pressed position for at least 30 seconds. This input will now be ignored. This input is not available in all installations.</p> | <p>Verify the COM CHAN UP key/switch is not stuck. Contact dealer for service if this message persists.</p> |
| <p>REMOTE KEY STUCK - Com remote frequency decrement key is stuck.</p> | <p>The remote com frequency decrement (COM CHAN DN) key/switch has been in pressed position for at least 30 seconds. This input will now be ignored. This input is not available in all installations.</p> | <p>Verify the COM CHAN DN key/switch is not stuck. Contact dealer for service if this message persists.</p> |

| Message | Description | Action |
|--|--|--|
| REMOTE KEY STUCK - Nav remote transfer key is stuck. | The remote nav transfer (NAV RMT XFR) key/switch has been in pressed position for at least 30 seconds. This input will now be ignored. This input is not available in all installations. | Verify the NAV RMT XFR key/switch is not stuck. Contact dealer for service if this message persists. |
| VLOC RECEIVER - Navigation receiver needs service. | The nav radio is reporting that it needs service. The nav radio may continue to function. | Contact dealer for service. |
| VLOC RECEIVER - Navigation receiver has failed. | The nav radio is not communicating properly with the system. | Contact dealer for service. |

Table 4-2 Messages

This page intentionally left blank

INDEX

A

Appendix 4-1

B

Basic operation 2-1

Brightness 3-19

C

Cautions ii, 2-6

Clear 1-3

Com database frequencies 3-5, 3-6, 3-7,
3-8, 3-9

Com frequencies 3-2

Com PTT 3-18

Com radio 2-1

Com;Select frequency 2-1

Com spacing 3-18

Com user frequencies 3-3

Com volume 1-2

Contrast 3-20

Controls 1-2

Cursor 1-3

Customer service i, 4-1

D

Database frequencies 3-5, 3-13, 4-3

Database look-up 2-4

Display brightness 3-19

DST 2-9

Duplicate identifiers 3-14

E

Emergency channel 2-5

Enter 1-3

F

Flight Service Station 3-8

FLIP/FLOP key 1-3

Fly.Garmin v, 3-22, 4-1, 4-3

Frequency monitoring 2-2

Front panel description 1-1

FSS 3-8

Functions 1-4, 3-1

G

Getting started 1-1

I

ICS 3-15

ID 1-2

Intercom 3-17

K

Knobs 1-3

L

Locking screw 1-1

M

Menus 1-3

Message 4-4

Monitoring 1-4, 2-2

Morse code 1-1

N

Nav audio 2-7

Nav database frequencies 3-13

Nav frequencies 3-10

Nav ID 1-2

Nav radio 2-6

Nav;Select frequency 2-6

Nav user frequencies 3-11

Nav volume 1-2

Nearest airport 3-6, 3-7

O

OBS mode 1-3, 2-8

P

Pilot controls 1-2

Power on 2-1

Power-up 3-22

Product description 1-1

Product Support v, 4-1

R

Recent com frequencies 3-2
Recent nav frequencies 3-10
Record of Revisions vi
Registration v
Remote frequency control 2-5
Reverse look-up 2-4
Revisions vi

S

Saving a com channel 2-2
Saving a nav channel 2-6
Serial Number 3-22
Software version 3-22
Speaker On/Off 3-17
Squelch 1-2
Stuck mic 2-5
Support v
System configuration 3-18

T

Timers 3-23
To-From 1-3
Troubleshooting 4-1, 4-4

U

Updating frequency database 4-3
USB 1-4, 3-21
User frequencies 3-3, 3-11

V

Volume 1-2

W

Warranty i



© 2012 GARMIN Corporation

GARMIN International, Inc.
1200 East 151st Street, Olathe, Kansas 66062, U.S.A.
Tel. 913/397.8200 or 800/800.1020
Fax 913/397.8282

Garmin AT, Inc.
2345 Turner Rd., S.E., Salem, Oregon 97302, U.S.A.
Tel. 503/581.8101 or 800/525.6726
Fax. 503/364.2138

Garmin (Europe) Ltd.
Liberty House, Bulls Copse Road, Hounslow Business Park,
Southampton, SO40 9RB, U.K.
Tel. +44 (0) 870 850 1243
Fax +44 (0) 238 052 4004

GARMIN Corporation
No. 68, Zhangshu 2nd Road, Xizhi Dist., New Taipei City 221, Taiwan (R.O.C.)
Tel. 886/2.2642.9199
Fax 886/2.2642.9099

Garmin Singapore Pte. Ltd.
46 East Coast Road
#05-06 Eastgate
Singapore 428766
Tel. (65) 63480378
Fax (65) 63480278

www.garmin.com
<https://fly.garmin.com/fly-garmin>

Part Number 190-01182-01 Rev. A